

AIRSTAGE™ V SERIES

Variable Refrigerant Flow System

Multi Air Conditioning System for Buildings



Large Capacity Multi VRF System
DC Inverter Control Compressor
Long Piping System Design
High Efficiency Refrigerant R410A



Building air conditioning developed to care for people and their surroundings



Large Capacity Multi VRF System

The ability to connect 3 outdoor units together in series up to a total capacity of 42HP (120kW) in each 2HP offers greater design freedom, reducing the number outdoor units and piping installation space compared the conventional models.

DC Inverter Control Compressor

The introduction of high efficiency DC inverter compressors and the latest in control technology provides more precise operation, improving system efficiency, resulting in energy saving and better economy.

Long Piping System Design

Maximum piping length 150m. Key design features allows 60m between the first separation tube and farthest indoor unit. This also allows use in large buildings and provides a high degree of design flexibility.

High Efficiency Refrigerant R410A

The V series systems operates using the zero ozone layer depleting potential, high efficiency refrigerant, R410A. This refrigerant provides increased energy efficiency, system performance and heat transfer, resulting in a reduction in pipe sizes compared to previous models. This also leads to cost savings during the installation phase of a project.

AIRSTAGE™ V SERIES

Variable Refrigerant Flow System

Multi Air Conditioning System for Buildings

Contents

■ V series features

- 1. HIGH RELIABILITY..... 4
- 2. IMPROVED COMFORT..... 6
- 3. HIGH EFFICIENCY OPERATION..... 8
- 4. DESIGN FREEDOM..... 10
- 5. EASY INSTALLATION..... 12
- 6. SERVICE & MAINTENANCE..... 14

■ Control

- Control System..... 16
- Comparison with Controllers..... 18
- Wiring System..... 19
- PC Controller..... 20
- Central Remote Controller..... 22
- Group Remote Controller..... 24
- Wired Remote Controller..... 26
- Simple Remote Controller..... 27
- Wireless Remote Controller..... 28
- External Switch Controller..... 29
- IR Receiver Unit..... 29
- BACnet® Gateway..... 30
- Network Convertor for LONWORKS®..... 31
- Network Convertor..... 32
- Transmission Adapter..... 33
- Signal Amplifier..... 33
- Service Tool..... 34
- Web Monitoring Tool..... 36

■ Outdoor units

- Line Up..... 38

■ Indoor units

- Line Up..... 40
- Compact Cassette..... 42
- Cassette..... 44
- Compact Duct..... 46
- Low Static Pressure Duct / Duct..... 48
- High Static Pressure Duct..... 50
- Floor / Ceiling..... 52
- Ceiling..... 54
- Compact Wall Mounted..... 56
(Comfort model)
- Wall Mounted..... 58
- Ceiling Wall..... 60

■ Optional Parts..... 62



HIGH RELIABILITY

High reliability provides a constant comfortable indoor environment

Compressor rotation control

Improvement of long life by reducing compressor wear

In addition to control which reduces the number of times the compressor is started and stopped, the load at starting is shared and equalized by rotation control. This rotation improves the durability and reliability of each compressor.

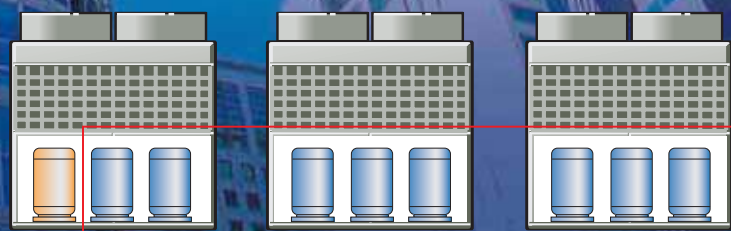

Compressor starting rotation (Constant speed)



Inverter



Constant speed

Emergency operation

Outdoor unit

Continuous operation is possible even in the unlikely event of compressor failure

There is no immediate system shutdown if trouble occurs in any compressor. The other compressors continue to operate on an emergency basis.

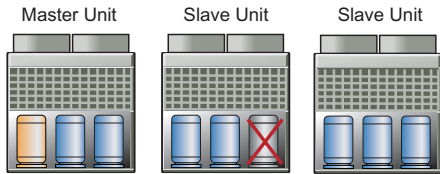

Indoor unit

Continuous operation is possible even if trouble occurs at an indoor unit

Each indoor unit is controlled individually on the system network. This allows all indoor units continue to run unaffected even if trouble should occur at any indoor unit(s) in one system.

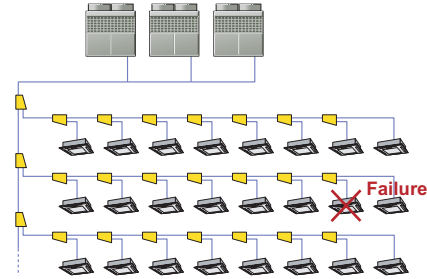

Optimum oil control

Stable operation of compressor by optimum oil control

- 1 High trapping efficiency, large capacity cyclone type oil separator
- 2 Oil balance control which maintains uniform oil levels
- 3 Optimum EEV control for oil and refrigerant circulation

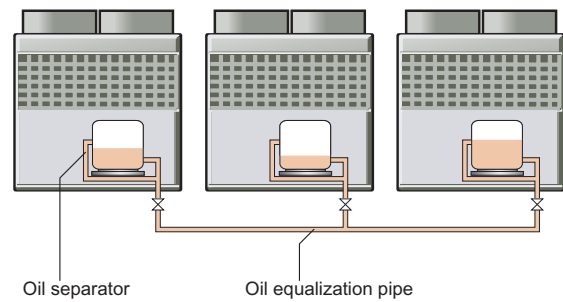

Blue fin heat exchanger mounted

Corrosion-resistance of the heat exchanger even in coastal areas has been improved by blue fin treatment of the outdoor unit heat exchanger.

Blue fin heat exchanger

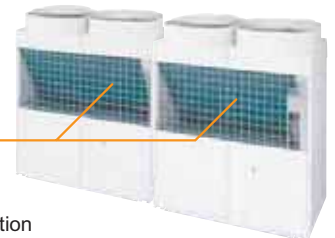
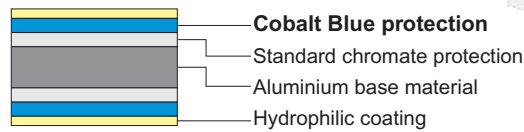

Web monitoring tool

UTR-YMSA

Trouble free operation at all times by web monitoring tool

The operational status of the VRF system within the building can be monitored in real time over the Internet.



Software

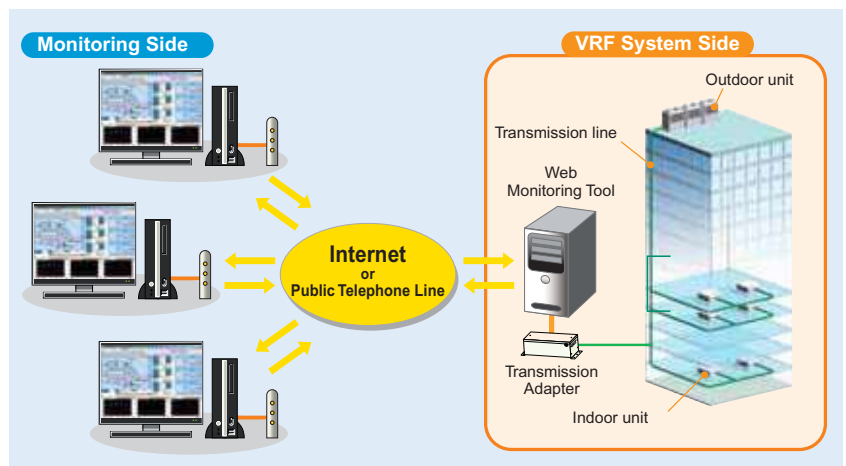

*Please contact your distributor for details.

IMPROVED COMFORT

Comfort ensured by high precision control technology

Individual air conditioning system

Pleasant air conditioning meeting individual room requirements.

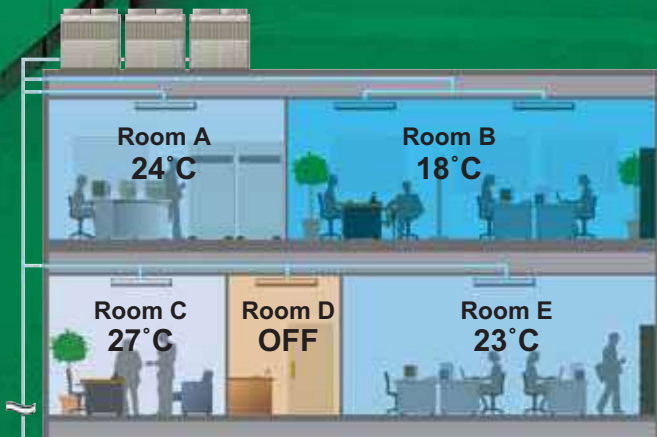

Liquid level balance control

Stable capacity and reduction of refrigerant noise by optimum state refrigerant

Balancing of the refrigerant in the system is optimized by liquid level balance control and subcool circuit between the receiver tanks of each outdoor unit. Stable refrigerant supply allows long pipe runs and achieves stable operational system performance whilst reducing unpleasant refrigerant noise.

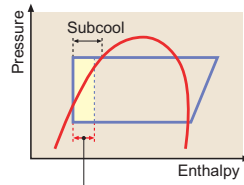

Increased refrigerant capacity by subcool

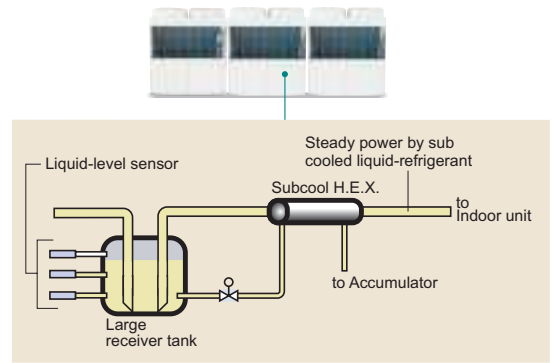

Room temperature control

Comfort at any time by high precision refrigerant flow control

High precision $\pm 0.5^\circ\text{C}$ ensures comfortable temperature control of the room. This is achieved by smooth refrigerant flow, controlled by inverter and by the indoor unit electronic expansion valve.

- Set temperature
- Conventional
- New model

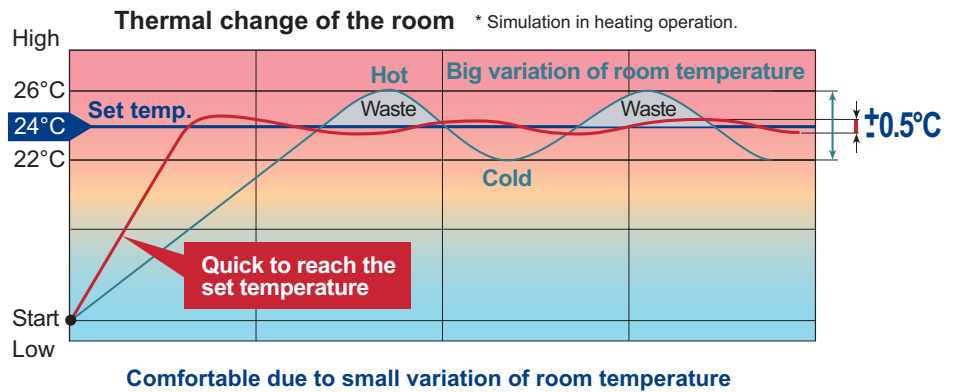

Inverter control

Comfort and energy saving achieved by implementation of inverter control

Comfort and energy saving is achieved by the adoption of linear step control in conjunction with inverter and constant speed compressor combination, which allows more precise control of the necessary refrigerant circulation amount required according to the system load. This also allows for a comfortable environment by use of smooth capacity control.

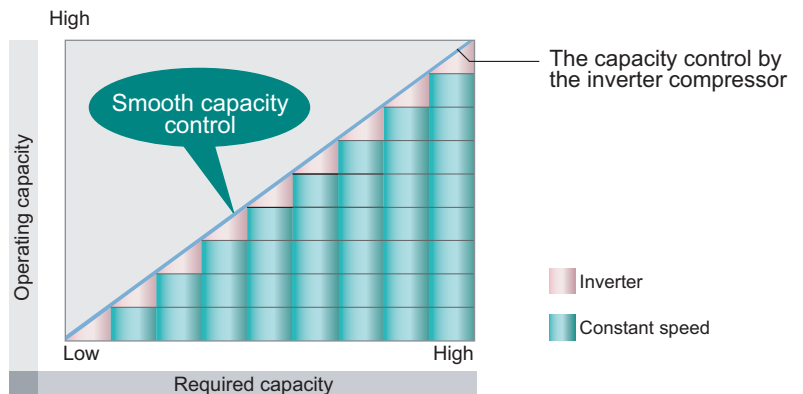

Super quiet

Outdoor unit

Quiet operating sound outdoor unit achieved

Operating noise has been reduced further through the application of a new dual casing bell mouth and large fan. The noise level can be reduced by 4-5dB (A) compared to normal operation by selecting silent operation.



Indoor unit

Quiet indoor units suited for bedrooms and other rooms which require quietness are available.



Compact Duct Silent Model



Low Static Pressure Duct Silent Model



Compact Wall Mounted Comfort Model

HIGH EFFICIENCY OPERATION

High efficiency operation system

Effective use of the heat exchanger of other outdoor units

This system takes advantage of the features of the multi type outdoor unit

The heat exchanger is operated at maximum efficiency by effectively using the heat exchanger of each outdoor unit reciprocally.

Example

The larger heat exchanger than the capacity of a compressor is used in each outdoor unit. (V series)

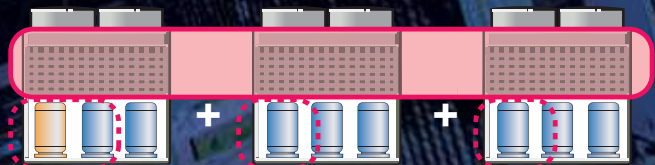

Conventional method

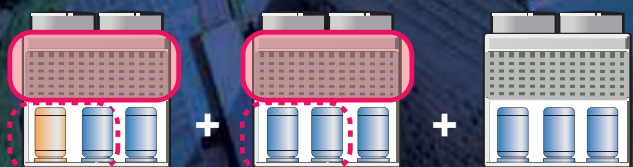

Large propeller fan

A newly designed fan is adopted for achieving higher performance and reducing the noise level.



Sine-wave DC Inverter Control

By adopting Sine-Wave DC Inverter Control for smoothing the motor running, energy saving and high efficiency operation are realized

Adopted Sine-wave DC inverter control

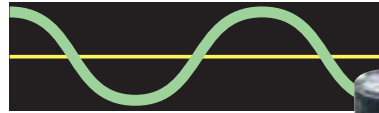

14HP (Master unit)

Equipped with DC inverter scroll compressor



DC inverter + Scroll compressor

By combining the DC inverter controlled scroll compressor with the constant speed scroll compressor, an operating system of energy saving and high efficiency is realized.

High efficiency

All key features of the outdoor unit result in a higher level of COP



* The data refers to a 10HP outdoor unit.

* "COP" is the coefficient of performance [= capacity (kW) ÷ input power (kW)].

※ COP values are base on our own testing method.

High efficiency refrigerant R410A

Improvement of operation efficiency realized by adoption of a new refrigerant



Refrigerant characteristics (Comparison of R22 / R407C / R410A)

Refrigerant	R22	R407C	R410A
Composition element	Single component	Blended (Zeotrope)	Blended (Near azeotrope)
Working Pressure (As compared to R22)	—	Similar	Higher (1.6 times)
Capacity (As compared to R22)	—	Similar	Higher (1.5 times)
Pressure Loss (As compared to R22)	—	Similar	Lower (0.6 times)
Total Efficiency (As compared to R22)	—	Similar	Higher (1.05 times)

DESIGN FREEDOM

Design features ensure solutions for all applications

Connectable large capacity

Indoor units up to 150% of the capacity of the outdoor unit can be connected

The Indoor unit connection ratio of this system can be from 50 to 150%(*1) of the outdoor unit capacity, thus achieving a high level of diversification with up to 48 indoor units (30 to 42HP) connectable on one refrigerant system.

*1 Indoor unit connectable capacity is 75 to 150% for single outdoor unit system (8 - 14HP) in case of including indoor unit model code 18 and under in the system.

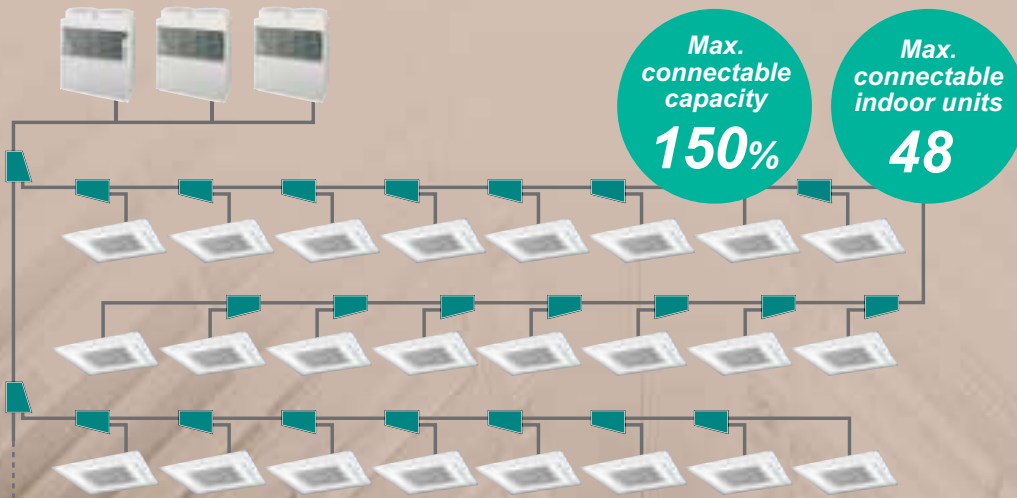

Note : When all indoor units are operating at maximum capacity individual indoor units operate at a slightly lower capacity.(When connecting more than 100%)

Low outdoor air temperature operation

Expansion of operating ranges

World's top class low outdoor air temperature operating range is achieved. This extends the potential locations for use to the cold regions of the world.



*1 Note : When outdoor units connect multiple, operating range is from -5°C to 43°C in cooling.

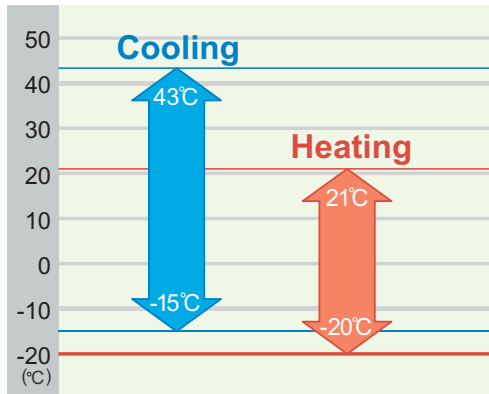

Long piping system design

With the V Series, installation up to a maximum piping length of 150m and a maximum height difference of 50m is possible. In addition, the piping can be extended up to a maximum of 60m from the first separation tube.

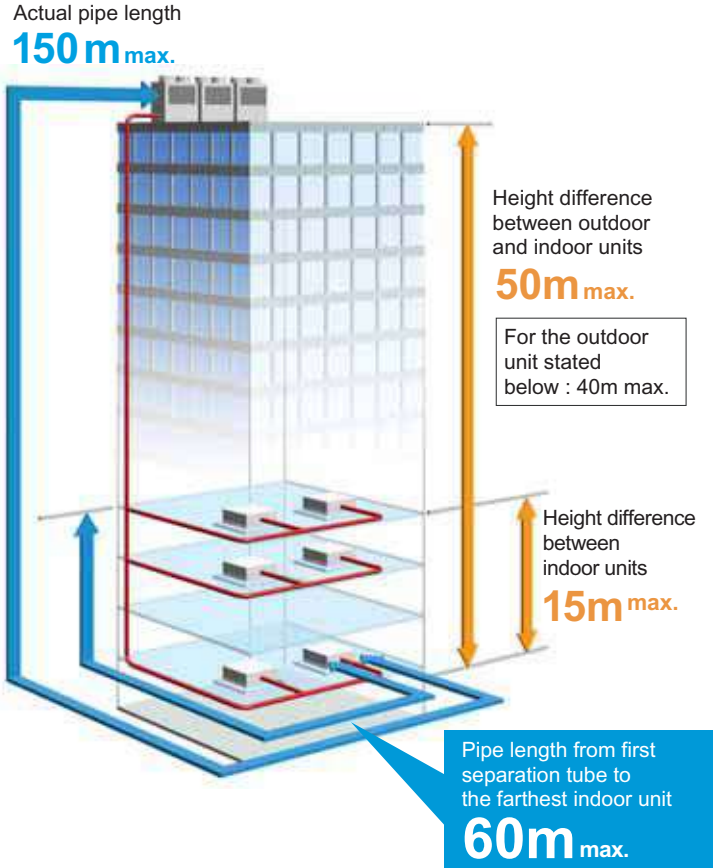

Compact outdoor unit improves effective use of space

Installation space can be reduced freeing up valuable building space

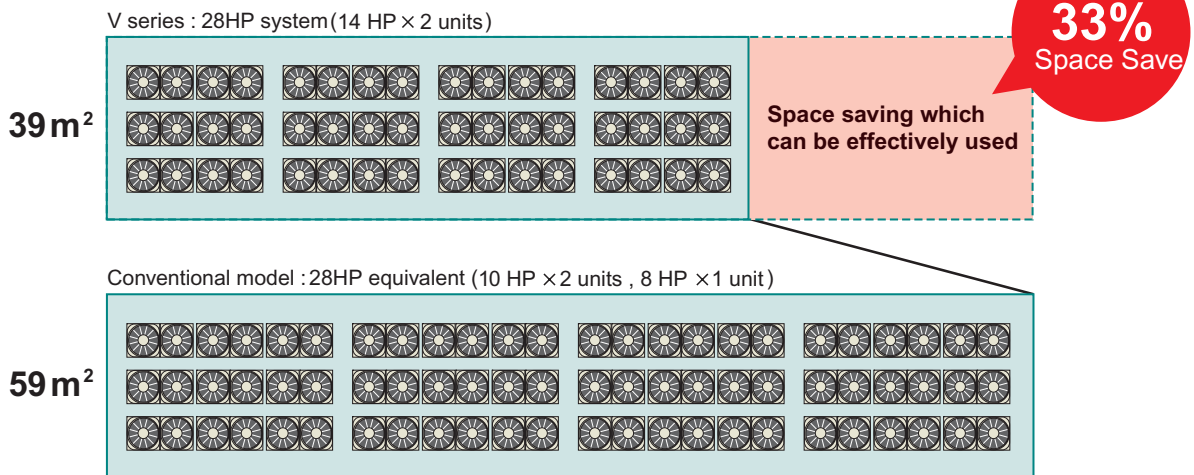

* 12 floors building (28HP capacity is required by each floor)

EASY INSTALLATION

Multi air conditioning system for large buildings with numerous superior construction work features

Simple communication wiring

Connection method simplifies installation and prevents errors

By using our wiring connection method, the wiring length is reduced compared to other wiring systems.

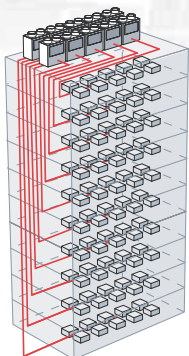

Other wiring method

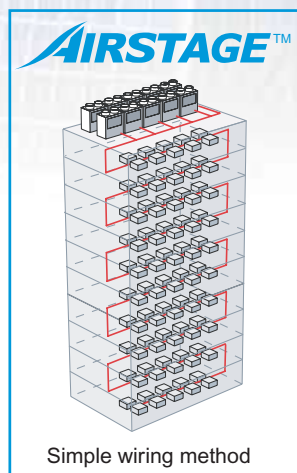

Simple wiring method

Simple piping system

Separation tubes and headers provide connection flexibility and simplicity reducing installation costs.

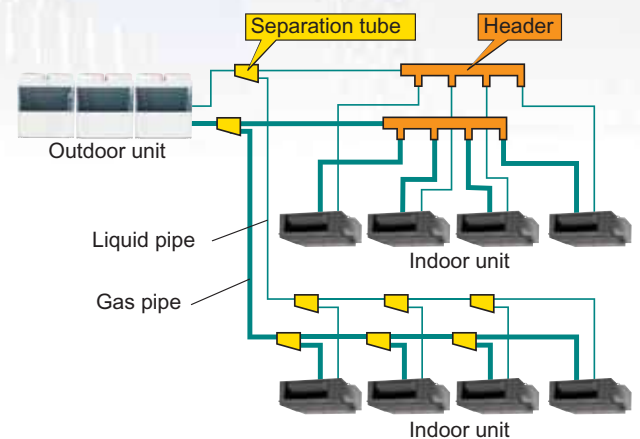

Piping system allows reduction of the number of pipes

Example: 90HP=10HP x 3units x 3

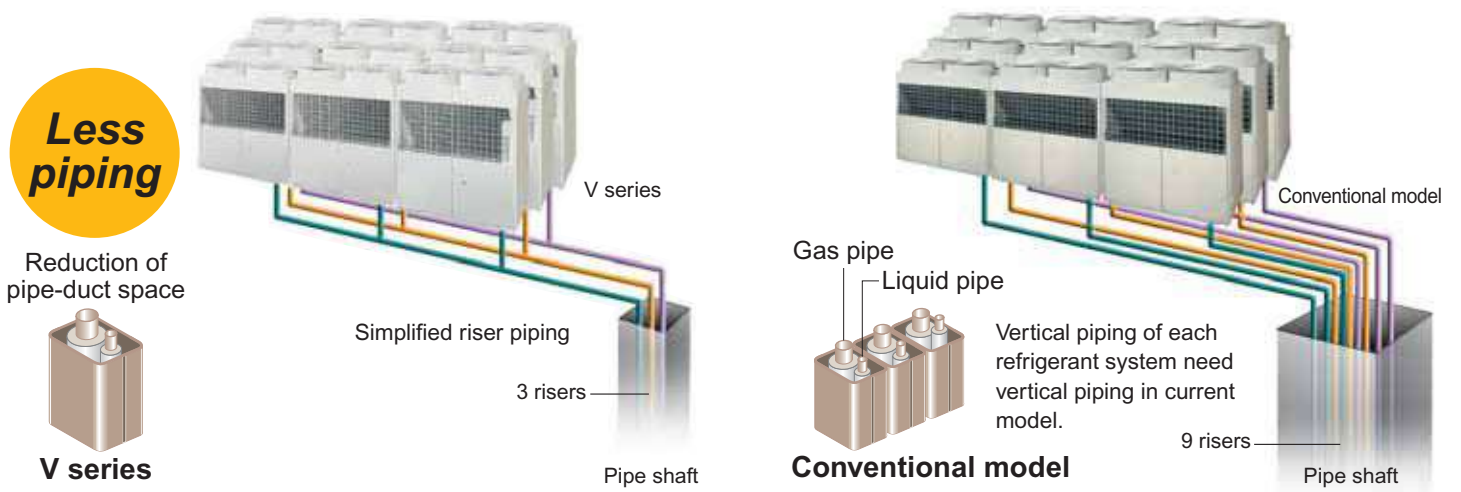

Compact outdoor unit can be carried in a small elevator

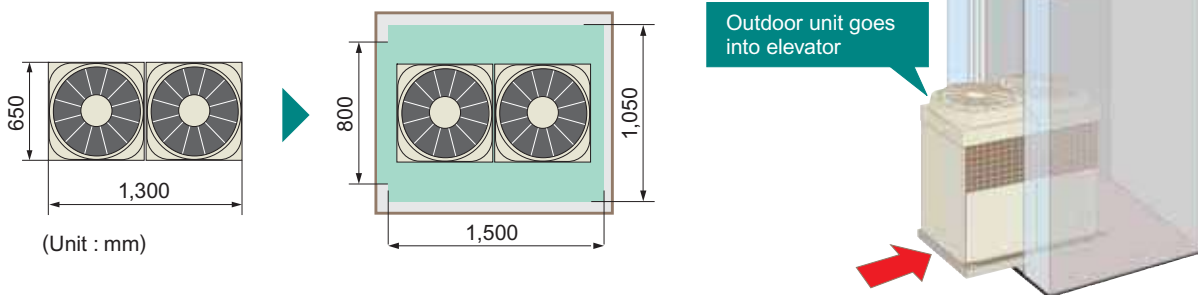

Lifting belt hooks convenient in crane work

Craning into place

The outdoor unit can be lifted by crane and set down on the building roof.

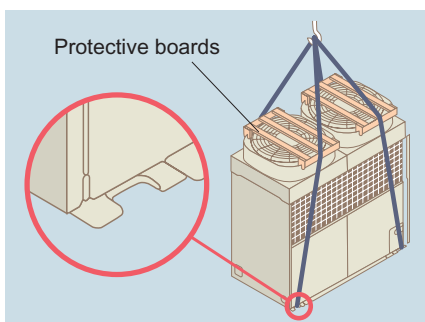

Easy removing pallet

Delivery pallet can be easily removed and installation work can be performed speedily.

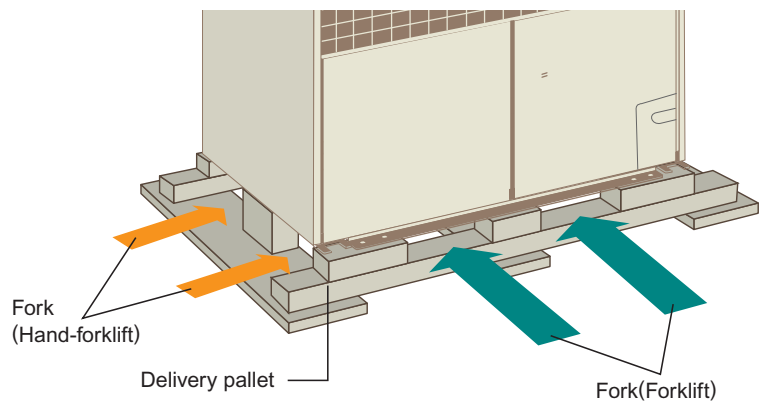

Pipe size reduction

Use of R410A refrigerant allows for a pipe size reduction compared to the conventional system. This offers improvement in construction work and a reduction in piping costs.

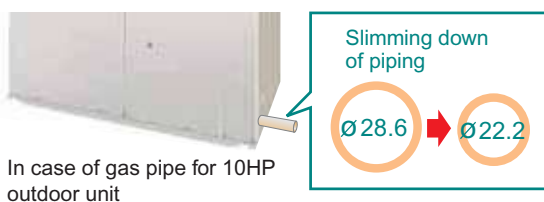

Choice of 4-direction piping connection

Piping connection

4-direction piping allows a variety of installation configurations. Easy installation and pipe direction setting.

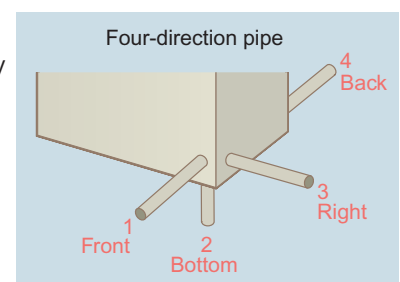

SERVICE & MAINTENANCE

This VRF V Series has numerous special features which incorporate our newest technology. Service and maintenance are performed accurately and speedily. Confidently use pleasant air conditioning anytime.

Improves maintenance and inspection mobility (Service Tool)

Extremely portable and convenient USB type adaptor was used. Connection anywhere in the VRF network is easy. Data can be collected from device sensors at a minimum interval of 2 second, and maintenance and inspection work can be performed easily.

Service Tool Software
UTR-YSTC

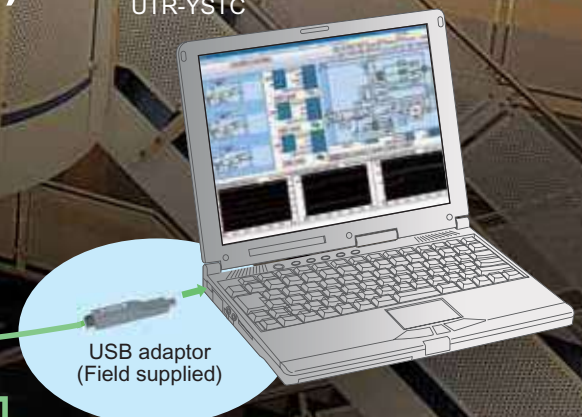
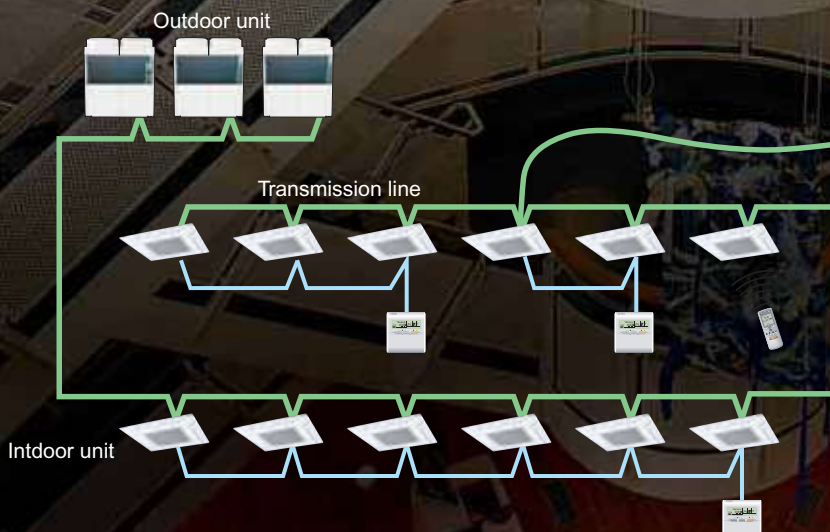

Operating display

Outdoor unit

By indicating the operating status and details of failures on a PCB in the outdoor unit, better service and quick and easy maintenance are possible.

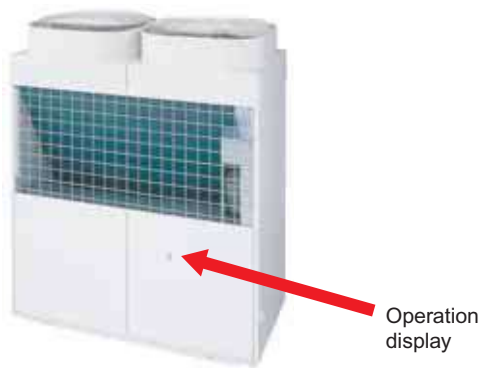

Indoor unit

The operation status of the indoor unit can be easily checked by operation indicator. In addition, when an error occurs, the error contents are displayed and repair work can be performed quickly.

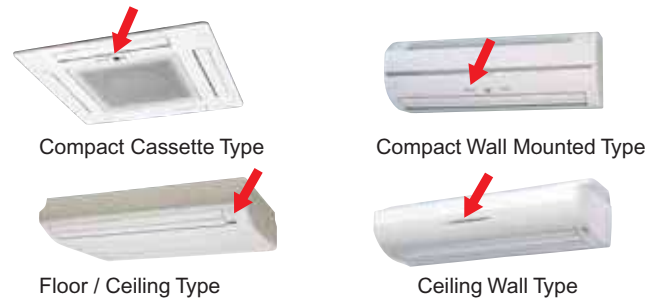

Note: For duct type indoor units, an IR receiver unit is necessary.

Error display with self-diagnosis function

When an error or abnormality occurred in the system, the indoor unit No. and error code at which the error occurred are displayed at the display section of the controller. (Except wireless remote controller)

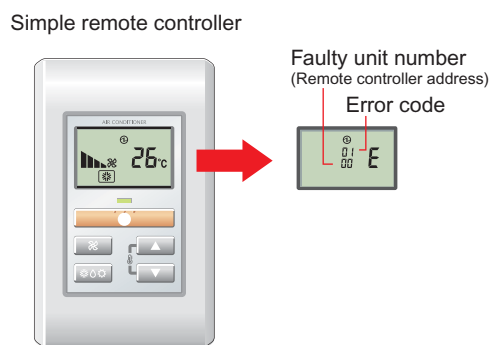
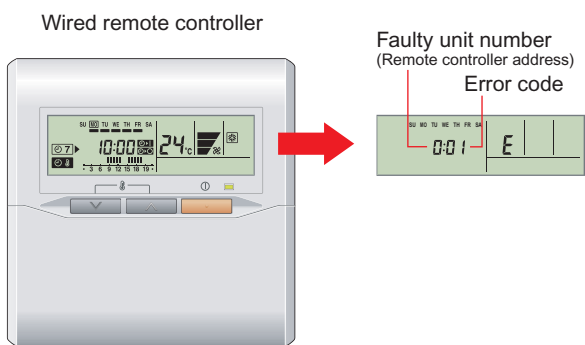

Drain pan cleaning is easy

Detachable drain pan simplifies removal of fallen leaves collected in the drain pan at the bottom of the heat exchanger

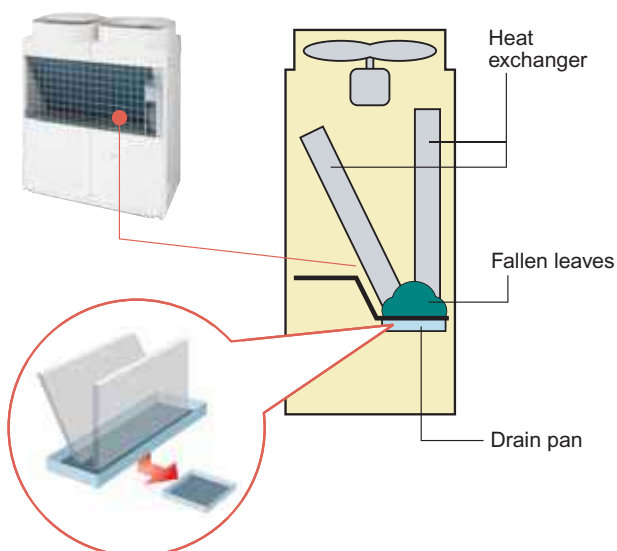

Easy replacement

Compressor can be moved by pull-out tray which simplifies inspection and replacement work. A pull-out plate ensures easy compressor replacement if necessary.

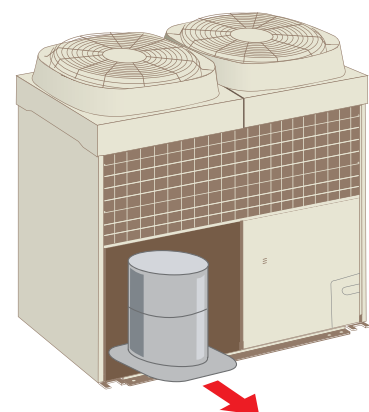

Control System

It supports every user's needs by offering a variety of control systems available, such as individual control, central control and building management system control options

CONTROL

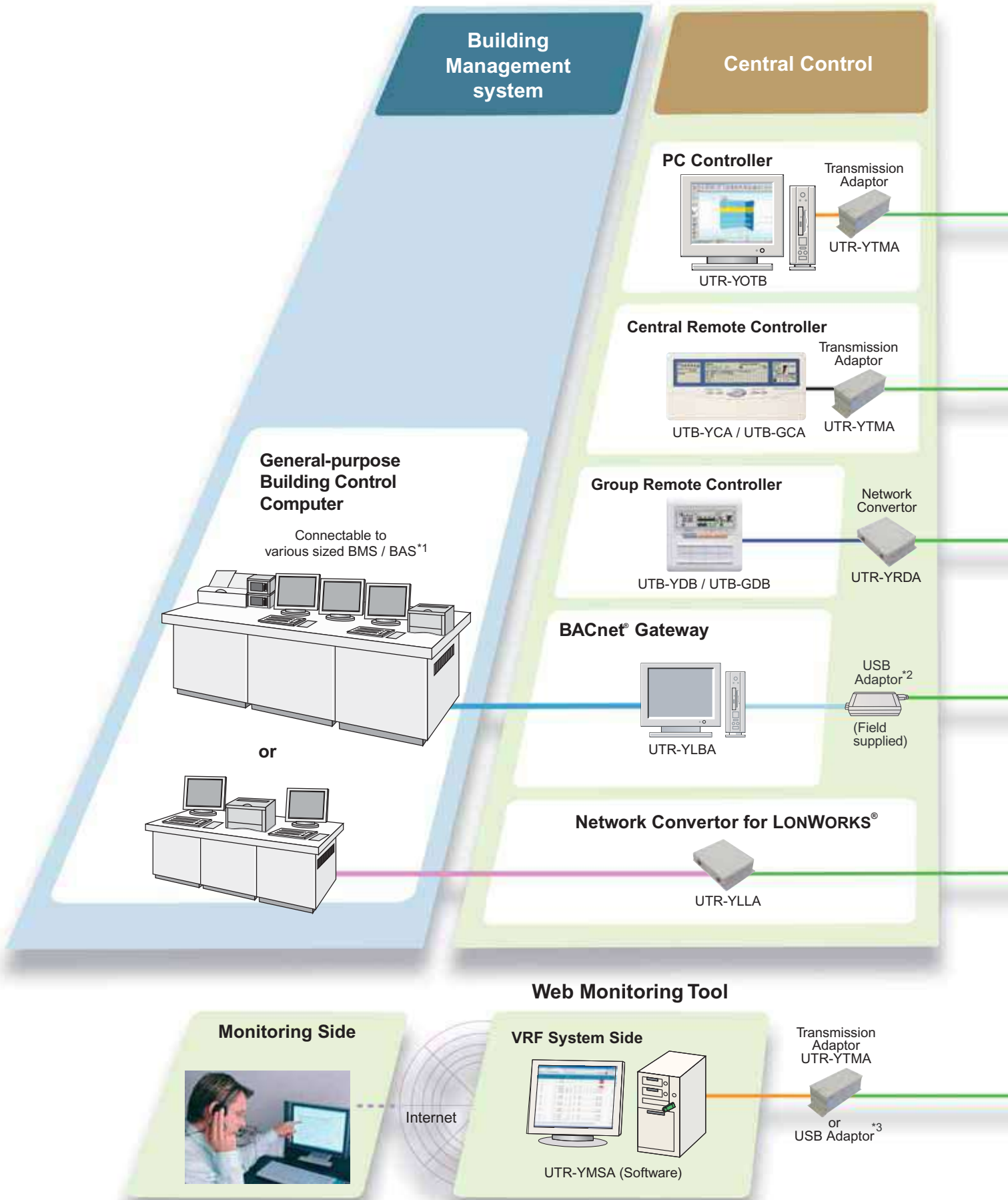

*1. BMS / BAS: Building Management System / Building Automation System
 *2. USB Adaptor is XLON® USB Adaptor of DH Electronics.
 *3. USB Adaptor is U10 USB Network interface of Echelon® corporation.

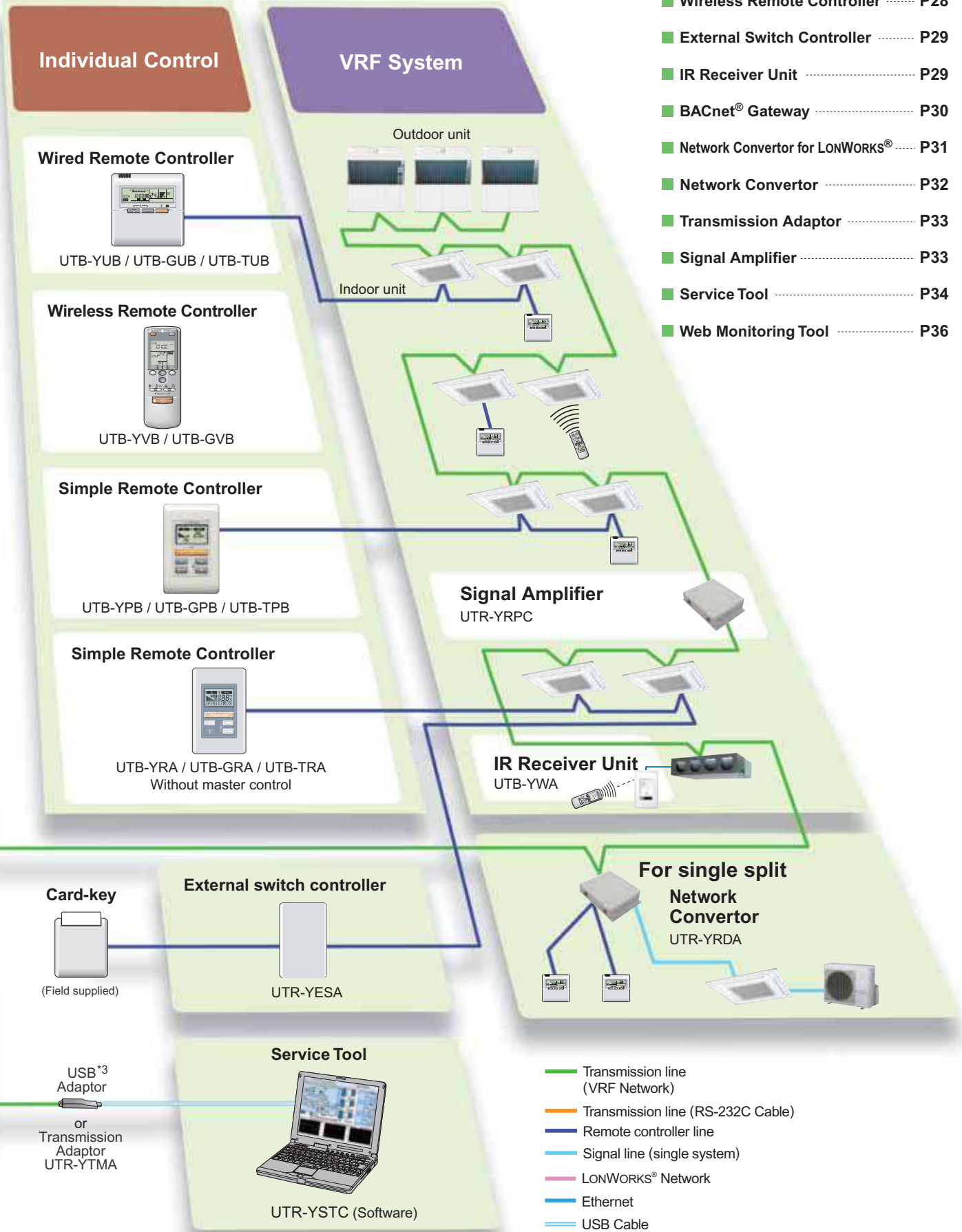

- PC Controller P20
- Central Remote Controller P22
- Group Remote Controller P24
- Wired Remote Controller P26
- Simple Remote Controller P27
- Wireless Remote Controller P28
- External Switch Controller P29
- IR Receiver Unit P29
- BACnet® Gateway P30
- Network Converter for LONWORKS® P31
- Network Converter P32
- Transmission Adaptor P33
- Signal Amplifier P33
- Service Tool P34
- Web Monitoring Tool P36

Comparison with Controllers

Item	PC controller (software)	Central remote controller	Group remote controller	Wired remote controller	Wireless remote controller	Simple remote controller	Simple ^{*2} remote controller
Model	UTR-YOTB	UTB-YCA UTB-GCA	UTB-YDB UTB-GDB	UTB-YUB UTB-GUB UTB-TUB	UTB-YVB UTB-GVB	UTB-YPB UTB-GPB UTB-TPB	UTB-YRA UTB-GRA UTB-TRA
Max. controllable remote controller groups	400	400	8	1	1	1	1
Max. controllable indoor units	400	400	96	16	16	16	16
Max. controllable groups	400	64	—	—	—	—	—
Air conditioning control function	On / Off	●	●	●	●	●	●
	Operating mode setting	●	●	●	●	●	—
	Fan speed setting	●	●	●	●	●	●
	Room temp. setting	●	●	●	●	●	●
	Test operation	●	●	—	●	●	—
	Up / down air direction flap setting	●	●	—	●	●	—
	Right / left air direction flap setting	●	●	—	●	●	—
	Auto restart ^{*1}	●	●	●	●	●	●
	Group setting	●	●	—	—	—	—
	RC prohibition	●	●	—	—	—	—
Display	Failure	●	●	●	●	—	●
	Defrosting	●	●	—	●	—	●
	Current time	●	●	●	●	●	—
	Day of week	●	●	●	●	—	—
	R.C.prohibition	●	●	—	●	—	●
	Cooling / heating priority	●	●	●	●	—	●
	Address display	●	●	●	●	—	●
Timer	On / Off timer	●	●	—	●	●	—
	Weekly timer	●	●	●	●	—	—
	Sleep timer	—	—	—	—	●	—
	Program timer	—	—	—	—	●	—
	On / Off per day	72	2	2	2	1	—
	On / Off per week	504	14	14	14	—	—
	Day off	●	●	—	●	—	—
	Min. unit of timer setting (Minutes)	10	10	10	30	5	—
Control	Status monitoring system	●	—	—	—	—	—
	Electricity charge calculation	●	—	—	—	—	—
	Error history	●	●	●	●	—	●

*1. Auto restart can be set by DIP switch on PCB inside of indoor unit.

*2. This controller is not available "master control" function.

PC Controller Software

UTR-YOTB

Max.
controllable
indoor units

400

Max.
controllable
groups

400

Max.
controllable
remote controller
groups

400

High performance and optimum control system for various building applications

- Up to 400 indoor units / 400 remote controller groups / 400 groups can be connected into one system for large scale buildings or hotels.
- Provides powerful functions for building air conditioning management, including electricity charge calculation and numerous data management functions, as well as standard equipment monitoring and control.

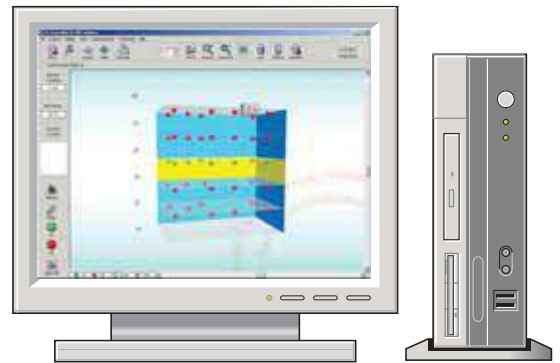

Functions

■ Central building monitoring and control

- Detailed settings can be programmed for each whole building / group / remote controller group.
- The PC controller and central remote controller can be used together to permit system control from two or more locations, if required.

■ Central control

Any of 6 functions of the individual remote controller can be locked to permit access from the PC controller: all functions, timer mode, operating mode, temperature setting, filter reset, on / off. Or the system can be set to allow control from the PC Controller only.



Operation Control

■ Auto mode (Priority-mode changer)

Auto mode function automatically switches between cooling and heating modes based on the temperatures set and the room temperature detected by the master indoor unit. Other operating indoor units can be operated in the same operating mode as master unit.

User-friendly Operation

- Runs under Windows® 2000 and Windows® XP Professional / Home so is as easy to use as a standard PC.
- Operational status can be color-coded for instant recognition: On / green, Off / red, test / orange, error / flashing.
- Operational status can be displayed according to user's preference.

Rotating 3-D Display

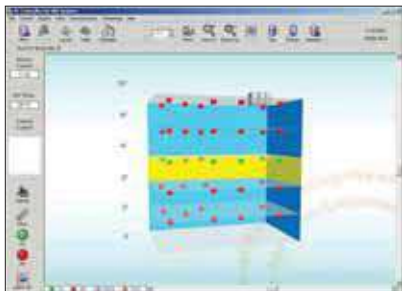

When monitoring and controlling the operations of a whole building.

Floor Layout Display

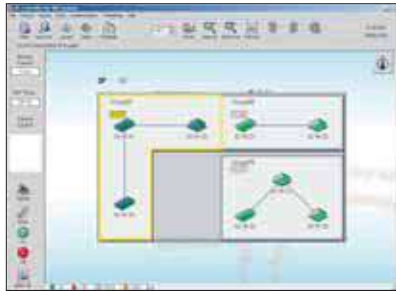

When monitoring and controlling the operations of each floor or group.

List Table Display



When monitoring and controlling each unit in detail.

Electricity charge calculation

- Total electricity charge, billed for multiple indoor units connected to the charge meter for air conditioning, is apportioned according to the accumulated operation time and indoor unit capacity.
- Allows accounting for special rates (e.g., for night or weekend use).
- Calculations can be printed as final bills.

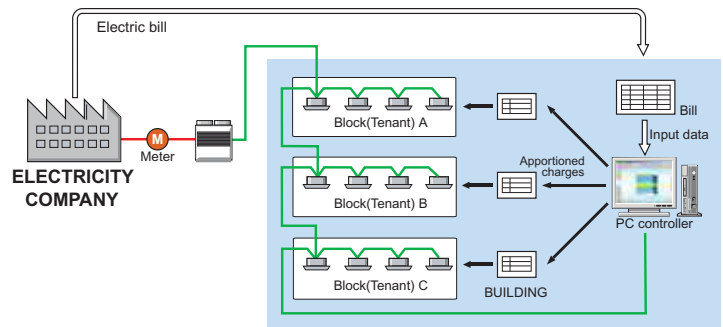

Note: This electrical power apportioning calculation is not official. When issued to the user as a bill, it must be explained to the user in advance.

Schedule control

- Annual schedules can be set for each remote controller group.
- Start / stop, operating mode, remote controller prohibition, and temperature settings can be recorded up to 72 times per day at 10 minute intervals for up to 6 configurations for each remote controller group.
- Settings can be made for periods straddling midnight.
- Allows programming of special settings for holidays, including public holidays, for a complete year.
- Standard 6 functions are available by schedule control.



Schedule Control

Error display

Audible alarms are accompanied by explanatory text. Up to 100 alarms can be recorded for each piece of equipment, this is particularly useful during maintenance.



Error Warning

Operating record

The operating status of indoor units and accumulated operating time of outdoor units can be logged and a daily or monthly report produced.



Operation Record

Pattern setting

Recognizes patterns of use, including ON/OFF, operating mode, and set temperature. An arbitrary pattern operation can be done by the touch of one button.

Easy Installation

- Simple connection by Transmission Adaptor and Interlink cable (Interlink cable field supplied).
- Easy software installation using just the CD provided.

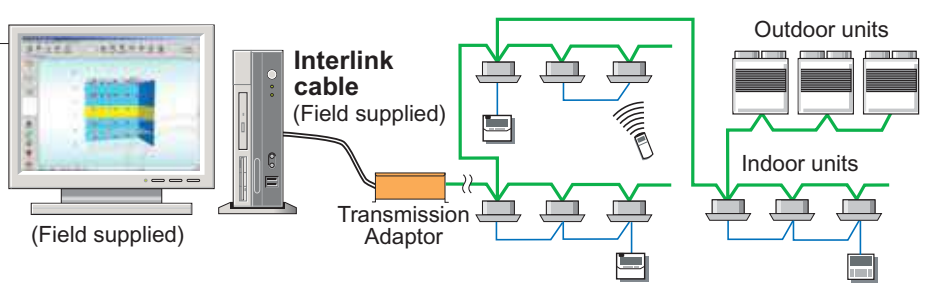

Requirements of PC for this software

Personal Computer	Operating System	AT compatible machine that runs Microsoft® Windows® Microsoft® Windows® 2000 Professional (English version / Service pack3 or later) Microsoft® Windows® XP Professional / Home (English version / Service pack1 or later)
	CPU	Intel® Pentium® / Celeron®, AMD Athlon™/ Duron™ 1GHz or higher
	HDD	4 GB or more
	Memory	256 MB or more
	Interface	Serial port and USB port
	Accelerator	Requires that the internal graphics accelerator be compatible with Microsoft® DirectX® 7.0 or later
Software		Adobe® Acrobat® Reader 4.0 or later
Hardware		Interlink cable (D-sub 9 pin female connector) [Field supplied]

<PACKING LIST>

Packing List	CD-ROM / Transmission Adaptor (UTR-YTMA) / Software Protection Key
--------------	--

Central Remote Controller

UTB-YCA / UTB-GCA

Max.
controllable
indoor units

400

Max.
controllable
remote controller
groups

400

Max.
controllable
groups

64

Functionality in a compact housing with built-in weekly timer

- Up to 400 indoor units / 400 remote controller groups / 64 groups can be controlled by one system.
- Up to 16 central remote controllers can be connected into one system allowing operation and monitoring to be achieved from the central control room, at each floor, by each tenant, or in the plant room.



Functions

Control up to 400 indoor units

- The central remote controller performs system control after you select All Groups, User Defined Groups, or Individual Remote Controller Groups.
- Accurate control of functions such as Start / Stop, Operating Mode, Temperature, and Air Velocity ensures occupancy comfort.

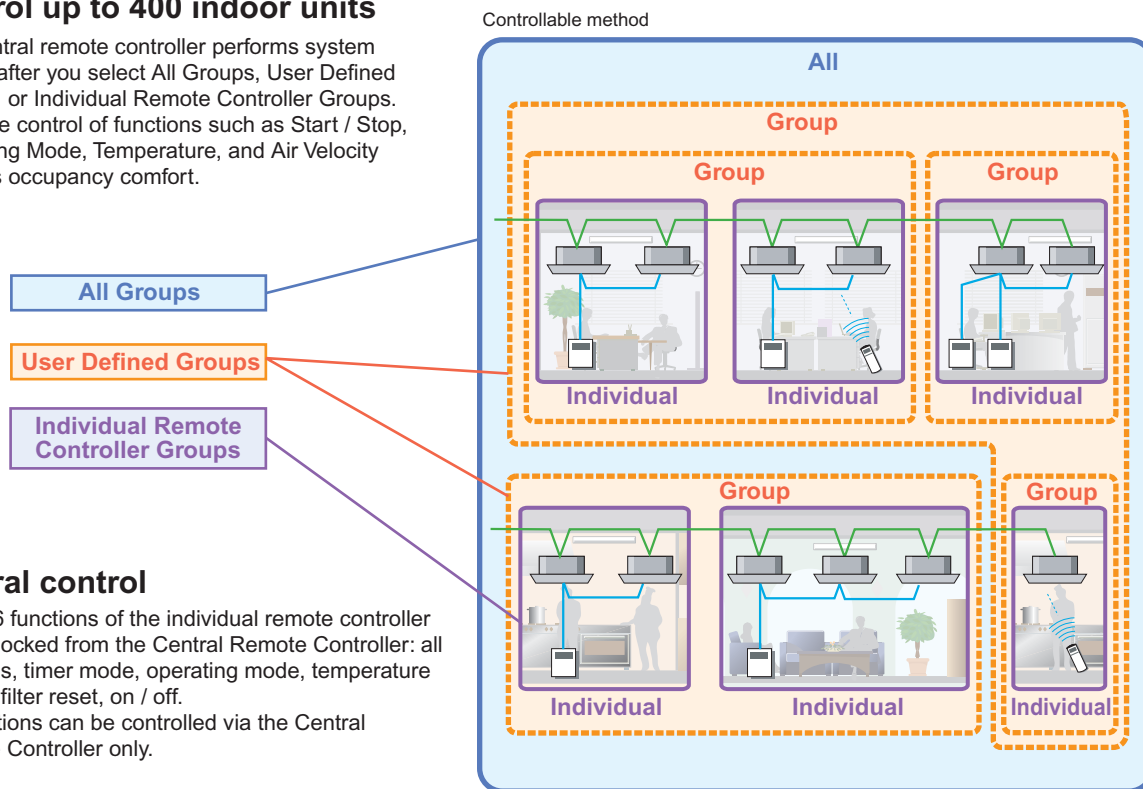

Central control

Any of 6 functions of the individual remote controller can be locked from the Central Remote Controller: all functions, timer mode, operating mode, temperature setting, filter reset, on / off. All functions can be controlled via the Central Remote Controller only.

Easy Operation

- Control functions are divided into three clusters: Timer Control, Central Control and Operational Control, which are clearly displayed.
- A large liquid crystal display clearly indicates which indoor unit is currently operating.

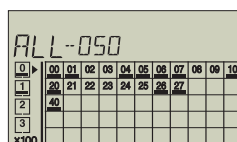

All Control Mode

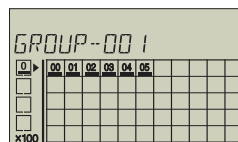

Group Control Mode

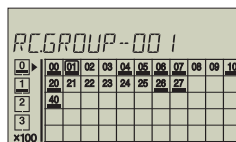

Individual Control Mode

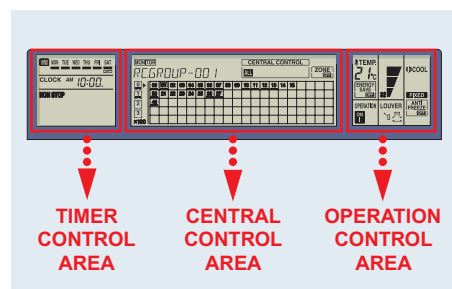

Built-in weekly timer

- Capable of controlling up to 400 indoor units, the timer function enables detailed scheduling for each remote controller group.
- A simple approach to system configuration reduces wiring costs.

- Allows two daily ON / OFF times for each day of the week.
- Allows time settings in 10 minutes increments.
- Time operations for a certain day can be temporarily cancelled by pressing the "DAY OFF" button in advance.
- Timer settings can be carried over to the following day.
- Daily time settings allow Copy and Paste functionality.

Example: Office

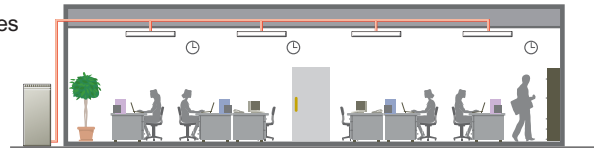

Weekly schedule

Example : Office

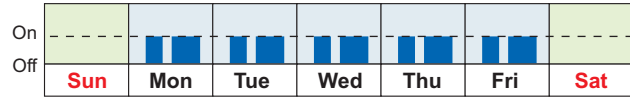

Operation : Monday~Friday 8:00~12:00 and 13:00~18:00

Memory functions

Central remote controller maintains original settings for all indoor units. This data can easily be transmitted to the system even after operating conditions have been changed.

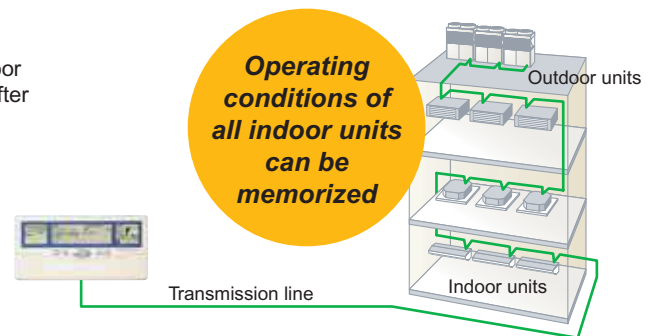

Error display

Error codes can be displayed for all indoor units and outdoor units. The last 2 error codes can be displayed, for easy inspection, service and maintenance.

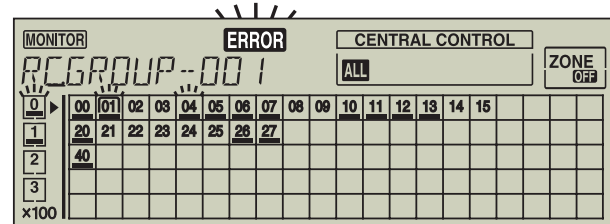

Simple and Convenient Installation

- The controller can be installed on any flat surface.
- The control panel and transmission adaptor can be installed separately.
- For flexibility in installation, the main unit can be built into the wall or exposed.

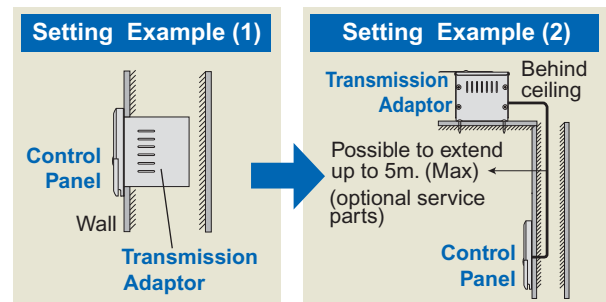
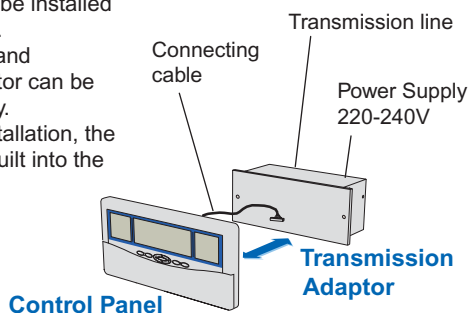

Specifications

Model	UTB-YCA / UTB-GCA	
	Control Panel	Transmission Adaptor
Power Supply	DC 12V	220-240V 50-60Hz Single phase
Power Consumption (W)		4.8
Fuse Capacity (A)		3
Dimensions (H x W x D)(mm)	143 x 296 x 22	107 x 288 x 100
Weight (g)	550	1,300
<PACKING LIST>		
Packing List	Control Panel / Transmission Adaptor / Connecting Cable	

Group Remote Controller

UTB-YDB / UTB-GDB

Max. controllable remote controller groups

8

Max. connectable Group R.C. in a VRF system

64

Group control of indoor units with simple operation

- Up to 8 remote controller groups can be controlled by a single controller.
- Up to 64 Group Remote Controllers can be connected in a single VRF system.
- Network Converter (UTR-YRDA) is required to connect Group Remote Controllers to a VRF system.



Functions

High performance and compact size

ON / OFF, operating mode, set temperature and air flow can be controlled / monitored centrally or individually.

Central control

+

ON/OFF control

+

Weekly timer



Control up to 8 remote controller groups

- A single Group Remote Controller controls and monitors up to 8 remote controller groups.
- Up to 64 Group Remote Controllers can be connected in a single VRF system.
- Up to 4 Group Remote Controllers can be controlled by a single Network Converter (UTR-YRDA).

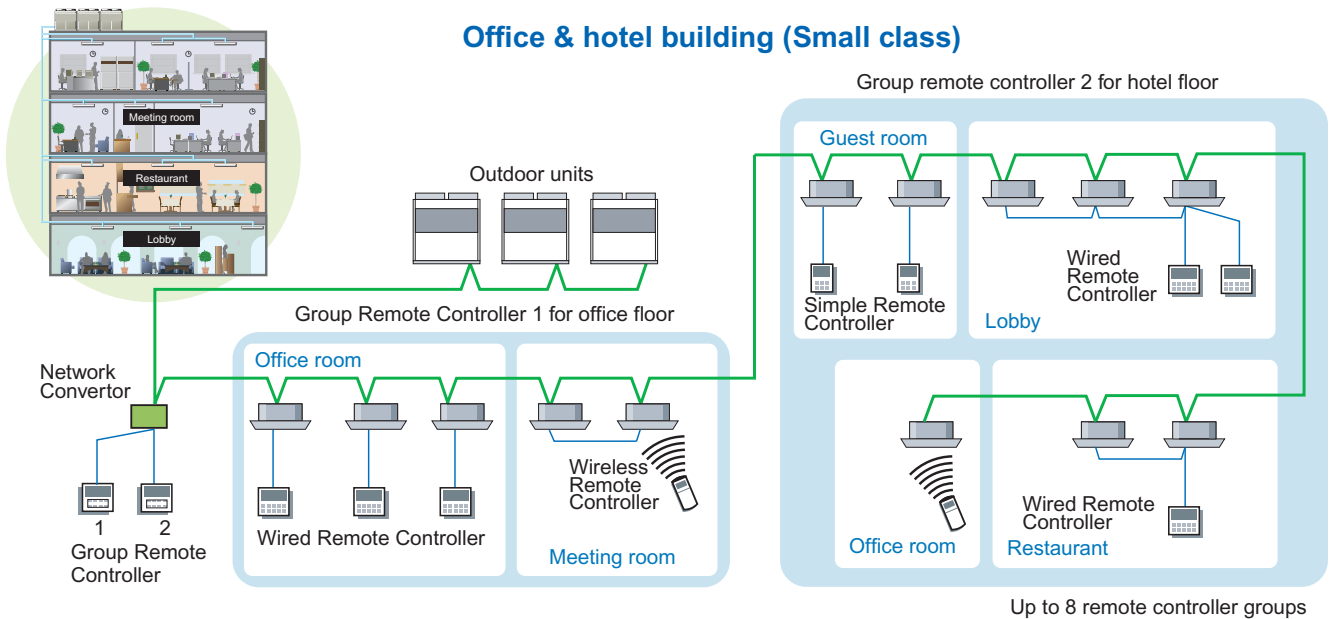

Built-in weekly timers

The weekly timer is provided as a standard function.

1. The timer can be set up for up to 4 times per day. (On / Off, operating mode, set temperature)
2. Allows separate settings for each day of the week.

ON / OFF switching

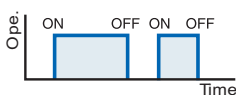

Air conditioning ON/OFF setting corresponding to air conditioning specification needs is possible.

Cooling / Heating switching

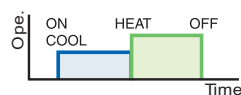

Switching between the cooling mode and heating mode can be set by time.

Temperature switching (Peak cut)

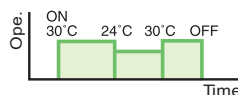

Since peak power cut is performed in a planned way, setting which changes the room temperature linked with time is possible.

Temperature switching (Anti-freeze)

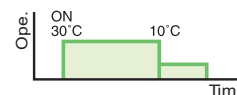

Low temperature heating operation can be set to prevent freezing in cold regions at night, etc.

Stop setting

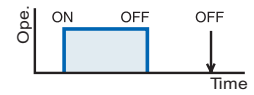

Indoor unit start/stop matched to the air conditioning operation end time is possible.

Useful functions

1 Timer setting at all the connected indoor units is possible by centralized timer on the front panel.

2 All the connected indoor units can be turned on / off simultaneously by centralized ON/OFF button on the front of the cover.

3 The indoor unit can be quickly turned on and off by ON / OFF button of each indoor unit on the front of the door.

With cover closed

Indoor Unit Operation Indicators

This shows the operating status and timer operation status for each of the indoor units.

■ : On □ : Off
⊙ : Timer operation ▼ : Selection

Operation Lamp

This is on if any of the indoor units is operating. This flashes if any of the indoor units has malfunction(s).

ALL OFF Button

Press the ALL OFF button to turn off all of the indoor units.

ALL ON Button

Press the ALL ON button to turn on all of the indoor units.

ALL TIMER Button

Press the ALL TIMER button to turn the timer operation on or off for all indoor units.

Start / Stop Button

Press the ON / OFF button to turn the corresponding indoor unit on or off.

Indoor Unit Name Labels

Write the names of the indoor units on the included labels and attach them.

Timer and Clock Display and setting

Setting Display

Day Display

Timer and Clock Display

Timer Mode Display

Timer Mode (DELETE) Button

DAY Button

Set Time Button

PROGRAM (CLOCK ADJUST) Button

ENTER Button

With cover open

Displaying the Status and Controlling indoor units

Transmission Display

Operation Lock Display

ON / OFF Display

Fan Speed Display

Set Temperature Display

Operation Mode Display

Start / Stop Button

Select Button

Fan Control Button

Master Control Button

Set Temperature Button

Specifications

Model		Group Remote Controller	
		UTB-YDB / UTB-GDB	
Power Supply		DC 12V	
Dimensions (mm)	Height	120	
	Width	120	
	Depth	17	
Weight (g)		200	

DC12V power supply is supplied by a network converter.

Wired Remote Controller

UTB-YUB / UTB-GUB / UTB-TUB

The room temperature can be controlled by detecting the temperature accurately from the built-in sensor

- Simple operation with Built-in Weekly / Daily Timer.
- A single controller controls up to 16 indoor units.
- Up to 2 wired remote controllers can be connected to a single indoor unit.

Max.
controllable
indoor units
16

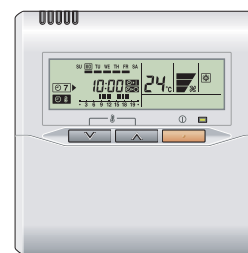

Functions

Powerful features and compact size

This Wired Remote Controller incorporates three primary functions into a single unit.



Accurate and comfortable

Indoor temperature can be detected accurately by the inclusion of a thermo sensor in the body of the wired controller. Our system can correspond to various scenes.

This new wired remote controller and the optional remote sensor allows flexibility in sensor location, suitable for all requirements.

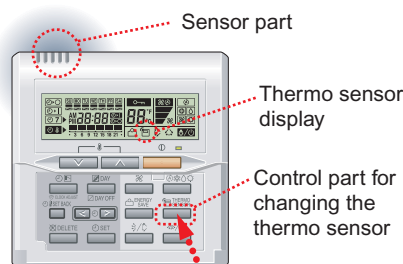

Example of changing sensor

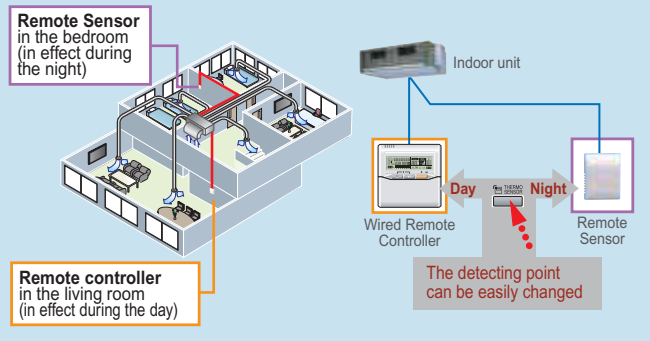

Displayed temperature is set temperature.

Built-in timers

Weekly timer :

Two ON / OFF times can be set for each day of the week.

Easy-to-understand time bar display



Setup screen example
(Set to Wednesday: 8:00 to 20:00.)

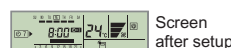

Setback timer :

Allows the user to set temperatures for two time spans over the course of each day of the week.



Setup screen example
(Set from Sunday to Saturday:
12:00 to 15:00, 28°C.)



At "Weekly timer" + "Set back timer" setup



Diagnosis check function

Two methods are available for determining the cause of failure in the event of a malfunction occurs:

- Malfunction diagnosis function
- Error history (Last 16 error codes can be accessed)

Simple installation

Can be mounted on the European Mounting Box (Installation dimension: 60mm) or the JIS Built-in Box (Installation dimension: 83.5mm).

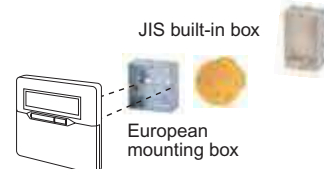

Specifications

Model		Wired Remote Controller	
		UTB-YUB / UTB-GUB / UTB-TUB	
Power Supply		DC 12V	
Dimensions (mm)	Height	120	
	Width	120	
	Depth	17	
Weight (g)		160	

DC12V power supply is supplied by the indoor unit.

Simple Remote Controller

UTB-YPB / UTB-GPB / UTB-TPB
UTB-YRA / UTB-GRA / UTB-TRA

Compact remote controller provides access to basic functions

- Up to 16 indoor units can be controlled with one remote controller.
- Suitable for hotels or offices which have many visitors coming in and going out and do not require detailed functions.

Max.
controllable
indoor units
16



UTB-YPB / UTB-GPB /
UTB-TPB



UTB-YRA / UTB-GRA /
UTB-TRA
Without master control



Functions

■ User-friendly operation

- Provides access to basic operations, such as Start / Stop, Fan Control, master control Switching, and Temperature Setting.
- A large Start / Stop button is provided in the centre of the remote controller unit for easy operation.
- Can be incorporated with the standard remote controller.
- Following an error display, Diagnostics can be carried out on the controller.

■ Background light

- Backlight enables easy operation in a darkened room.
- Backlight activates during all button operations, and lasts 10 seconds in operating mode and 5 seconds in stop mode after a button is pressed.



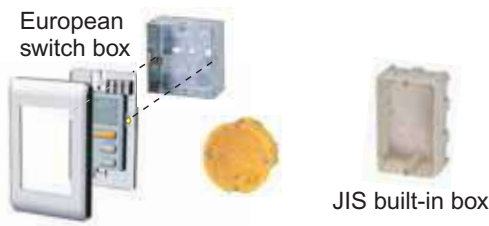

■ Simple installation

Can be mounted on the European Mounting Box (Installation dimension: 60mm) or the JIS Built-in Box (Installation dimension: 83.5mm).



■ Functions

Model		
Operation	UTB-YPB UTB-GPB UTB-TPB	UTB-YRA UTB-GRA UTB-TRA
Start / Stop	●	●
Fan control	●	●
Master control	●	— *1
Temp. setting	●	●

*1: This controller is limited a part of function.
It is recommend to use together with other type controller.

Specifications

Model	Simple Remote Controller	
	UTB-YPB / UTB-GPB / UTB-TPB	UTB-YRA / UTB-GRA / UTB-TRA
Power Supply	DC 12V	
Dimensions (mm)	Height	120
	Width	75
	Depth	14
Weight (g)	90 (100 : UTB-TPB)	90 (100 : UTB-TRA)

DC12V power supply is supplied by the indoor unit.

Wireless Remote Controller

UTB-YVB / UTB-GVB

Simple and sophisticated operations with a choice of 4 daily timers

- A single controller controls up to 16 indoor units.

Max. controllable indoor units
16

Selectable **4** daily timers



UTB-YVB / UTB-GVB



Functions

Built-in daily timer

Select from 4 different timer programs : On / Off / Program / Sleep

Program timer : The program timer operates the ON and OFF timer once within a 24 hour period.

Sleep timer : The sleep timer function automatically corrects the set temperature according to the time setting to prevent excessive cooling or heating during sleep hours.

Cooling operation/dry operation

When the sleep timer is set, the set temperature automatically rises 1°C every hour. The set temperature can rise up to a maximum of 2°C.

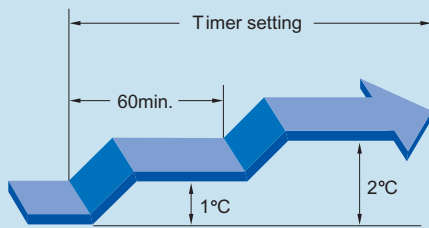

Heating operation

When the sleep timer is set, the set temperature automatically drops 1°C every 30 minutes. The set temperature can drop to a maximum of 4°C.

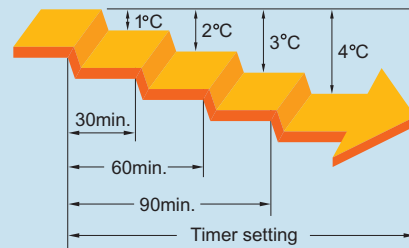

Easy installation and operation

- Code selector switch prevents indoor unit mix-up. (Up to 4 codes can be set.)

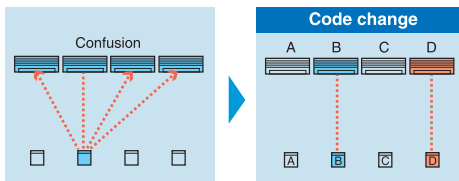

- Wide and precise transmitting range.

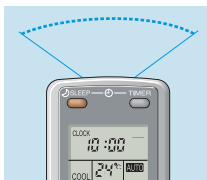

System addressing

- During installation work, system addressing can be performed using the wireless remote controller, thus eliminating manual switch setting.

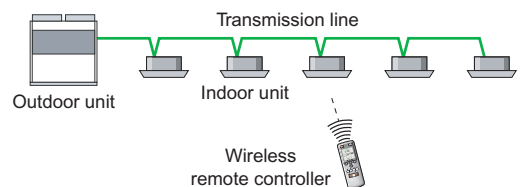

Specifications

Model		Wireless Remote Controller	
		UTB-YVB / UTB-GVB	
Battery		1.5V (R03 / LR03 / AAA) x 2	
Dimensions (mm)	Height	158	
	Width	56	
	Depth	20	
Weight (g)		70	

External Switch Controller

UTR-YESA

Air conditioner switching can be controlled by connecting other sensor switches

- In combination with a field supply Card-Key Switch or other sensor, the external switch controller allows control of the ON / OFF, Temperature, fan speed and operating mode functions. This makes this product suitable for installations such as hotel rooms.
- Card-key or other sensor switches are available as a field supplied parts.



Electrical wiring

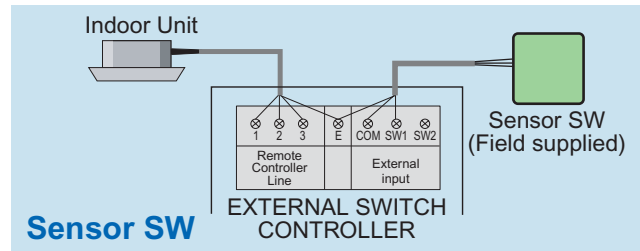
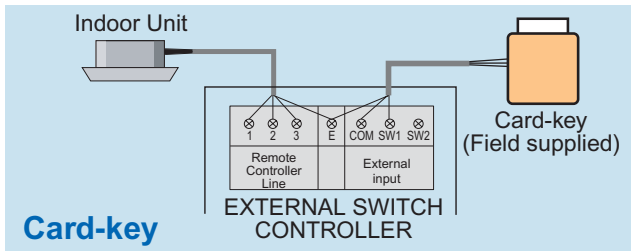

Installation example

- Auto mode operation, which switches the cooling and the heating automatically, is enabled by using the sensor switch and external switch controller.
- Note: All indoor units will operate in the same mode.

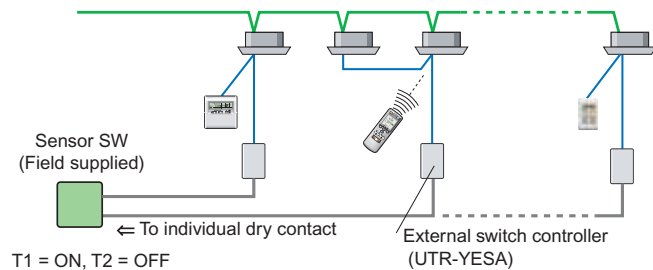
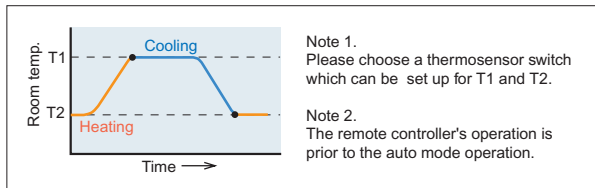

IR Receiver Unit

UTB-YWA

Necessary to control duct type by wireless remote controller



Wiring connection

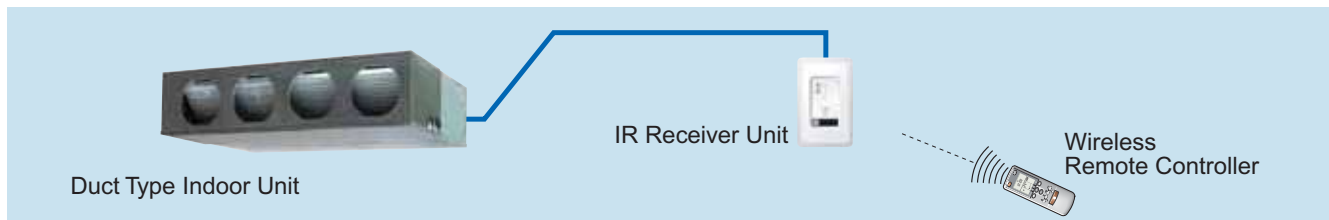

Specifications

Model	External Switch Controller		IR Receiver Unit	
	UTR-YESA		UTB-YWA	
Power Supply	DC 12V		DC 12V	
Dimensions (mm)	Height	120	Height	122
	Width	75	Width	60
	Depth	30	Depth	26.5
Weight (g)	90		150	

DC12V power supply is supplied by the indoor unit.

BACnet[®] Gateway Software

UTR-YLBA

Max. controllable

4

VRF system

Max. controllable

400

outdoor units

Max. controllable

1600

indoor units

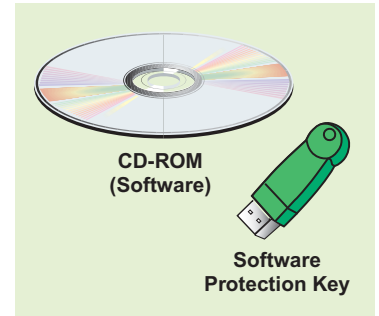

- The VRF system can be incorporated into a Building Management System.
- Enables central control of up to 1,600 indoor units through BACnet[®], a global standard for open networks.
- ANSI / ASHRAE Standards[®] 135-2001 BACnet[®] Application Specific Controller (B-ASC) BACnet[®] / IP over Ethernet.
- Connects up to 4 VRF systems (1,600 indoor units / 400 outdoor units) per gateway.
- Ideal for applications in high rise buildings and hotels, etc.

Installation example

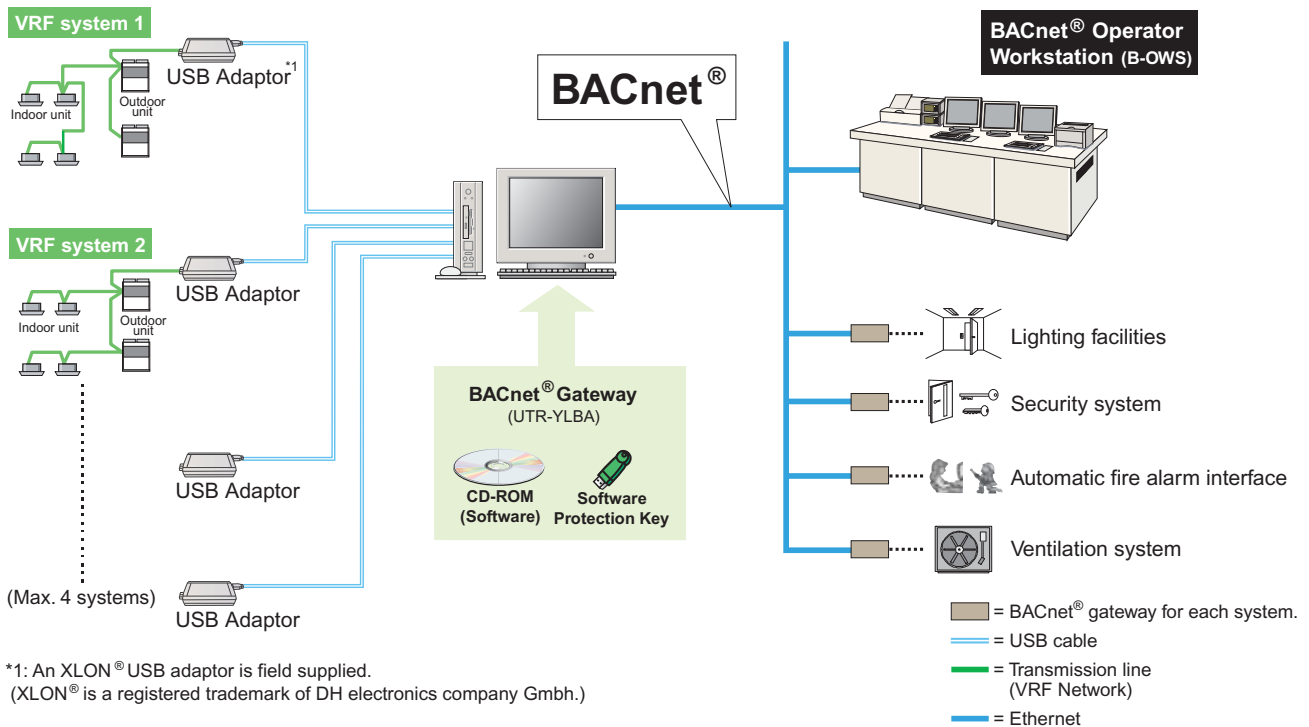

Requirements of PC for this software

Personal Computer	Operating System	AT compatible machine that runs Microsoft [®] Windows [®] Microsoft [®] Windows [®] 2000 Professional (English version / Service pack3 or later) Microsoft [®] Windows [®] XP Professional (English version / Service pack1 or later)	
	CPU	Intel [®] Pentium [®] III 400MHz or higher	
	Memory	256 MB or more	
	Display	1024 x 768 dots or more	
	Interface		LAN (10BASE-T / 100BASE-TX)
			USB 1.1
Required Hardware		*The power supply of 100mA / 5VDC is necessary for one USB adaptor. Personal Computer (Field supplied) USB Adaptor (DH electronics XLON [®] USB USB4-WM-FTT) (Field supplied)	
Required Software		*1 adaptor is necessary for 1 VRF system. Adobe [®] Acrobat [®] reader 4.0 or later	

<PACKING LIST>

Packing List	CD-ROM / Software Protection Key
--------------	----------------------------------

Network Converter for LONWORKS®

UTR-YLLA

Max. connectable
128
indoor units



- For connection between VRF system and a LONWORKS® open network for management of small to medium-sized BMS and VRF systems.
- The UTR-YLLA permits central monitoring and control of a VRF system from a BMS through a LONWORKS® interface.
- Up to 128 Indoor units can be connected to a single Network Converter.

Installation example

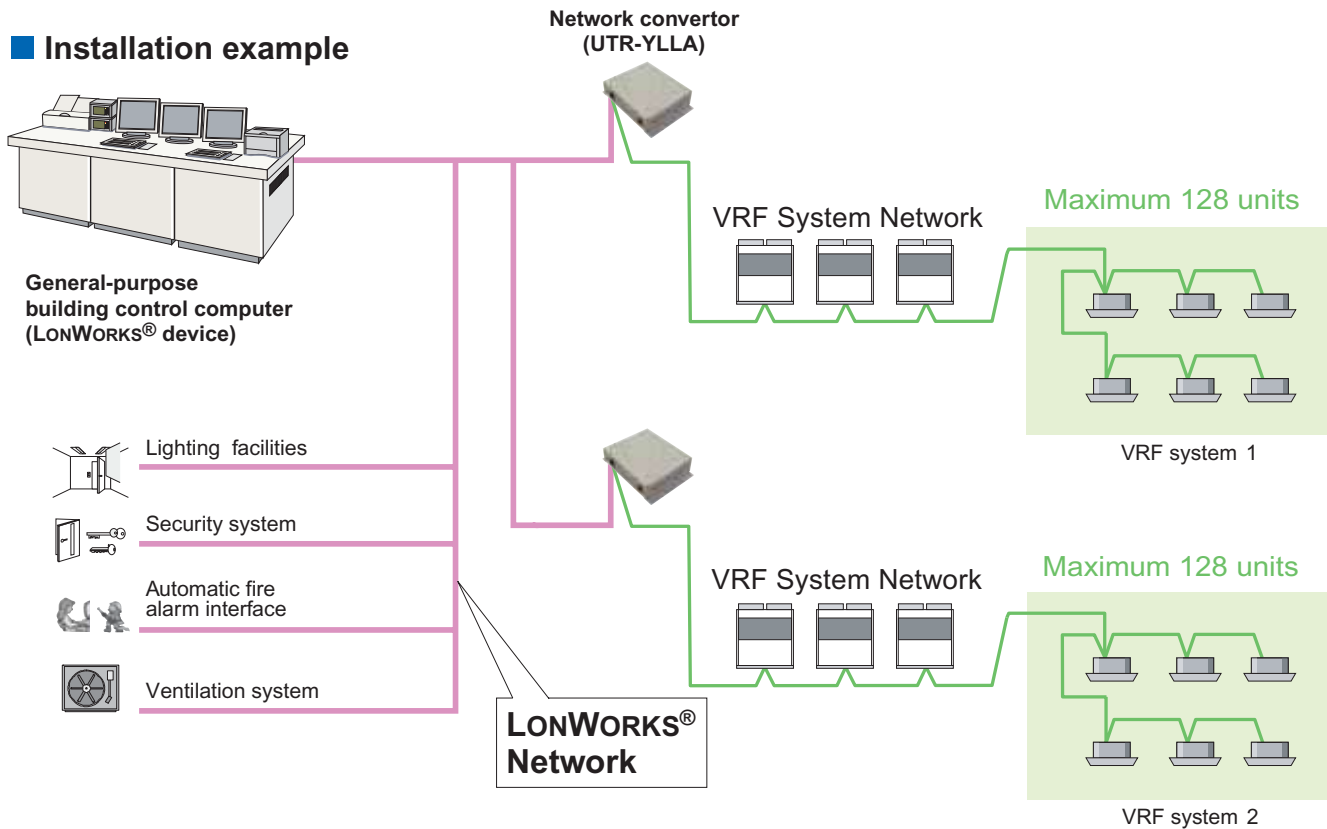

Specifications

Main specification

Power Supply	50-60Hz 220-240V
Power Consumption (W)	4.5
Dimensions (H X W X D) (mm)	67 X 288 X 211
Weight (g)	1,500

Transmission specification

BMS SIDE	
Transmission speed	78kbps
Transceiver	FTT-10A
Transmission way form	Free topology
Termined resistor	None (It attaches at the terminal of a network.)

Dimensions

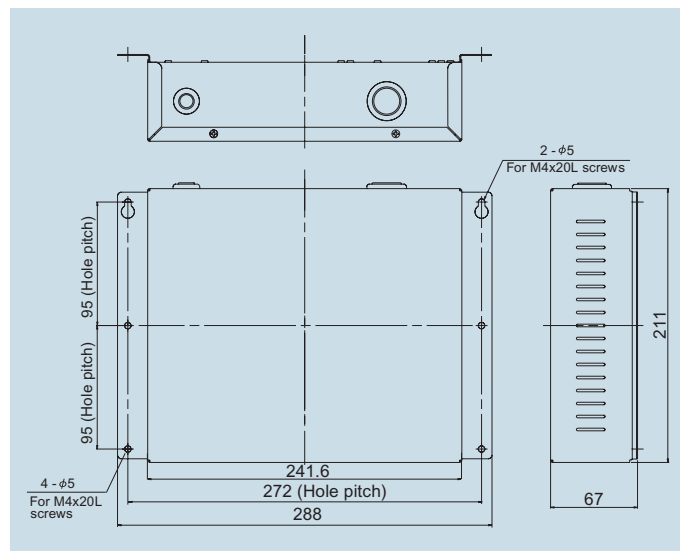

Network Converter

UTR-YRDA

- This network converter is to be used for connecting single split system or group remote controller (UTB-YDB / UTB-GDB) with the VRF system.
- Please select the function by switching the dip switch during the installation.



Installation example

- Split type systems can be controlled from a central remote controller or PC controller through connection to the VRF's network converter.
- Standard remote controller and central remote controller provide On / Off control, master control, temperature and fan control, etc.
- A single network converter can be used to connect and control up to 16 single units.

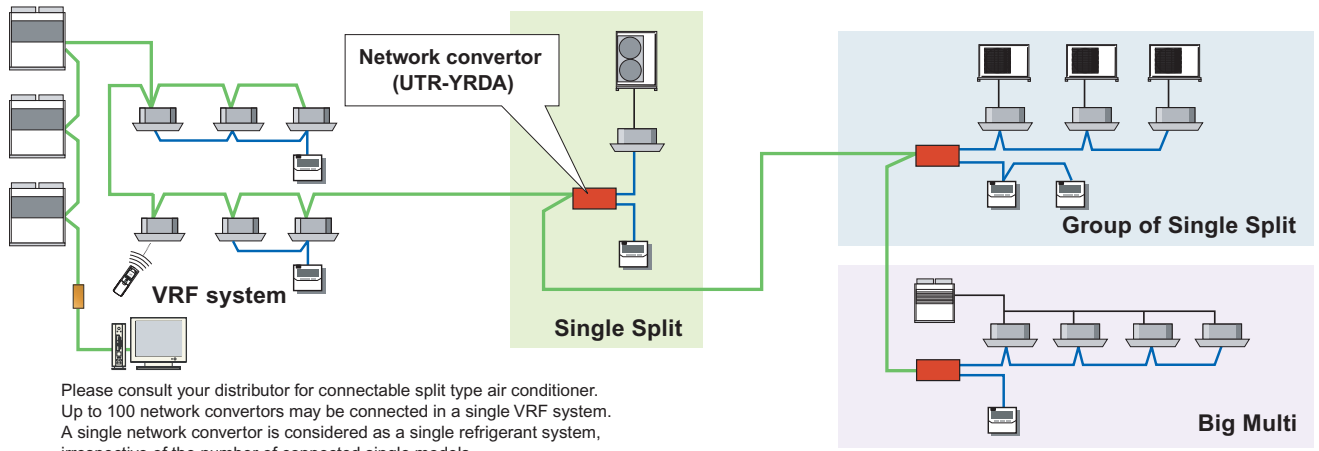

Please consult your distributor for connectable split type air conditioner. Up to 100 network converters may be connected in a single VRF system. A single network converter is considered as a single refrigerant system, irrespective of the number of connected single models.

- 4 group remort controllers can be connected to a single Network converter (UTR-YRDA).

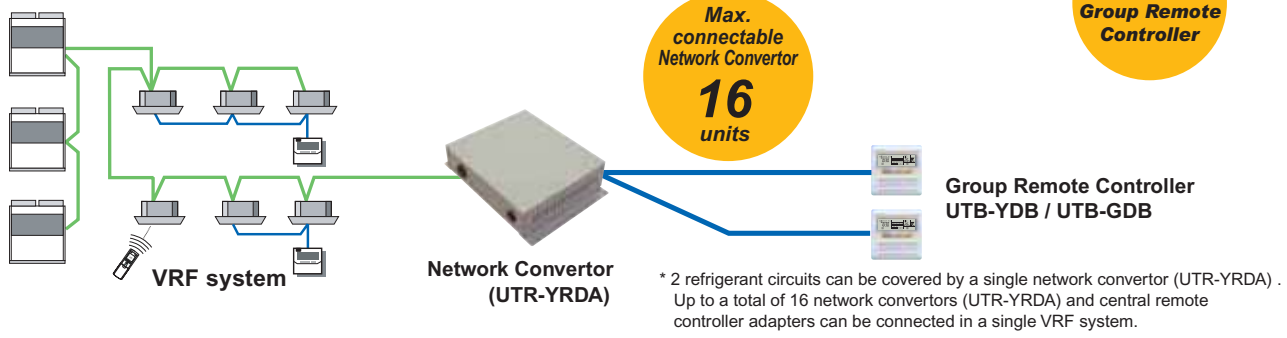

Specifications

Main specification

Power Supply	50-60Hz 220-240V
Power Consumption (W)	8.5
Dimensions (H X W X D) (mm)	67 X 288 X 211
Weight (g)	1,500

Dimensions

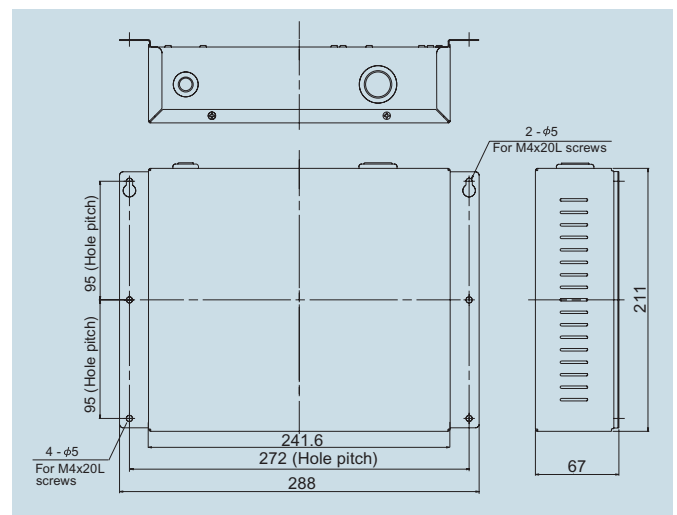

Transmission Adaptor

UTR-YTMA

- For air conditioning of the medium and large size buildings, the control software can control and monitor air conditioners together with the ones in the other buildings.
- This device enables control by other equipment via an Interlink cable or connection cable.
- Up to 400 Indoor units / 100 Outdoor units can be connected to one Transmission Adaptor.



Installation example

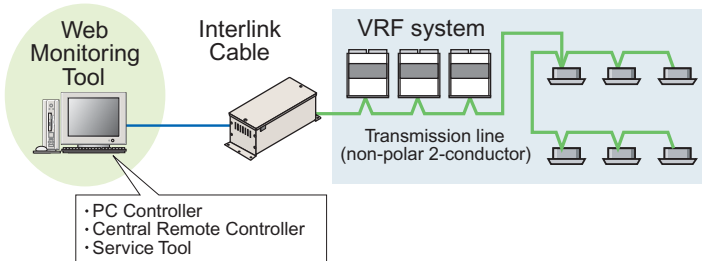

Dimensions

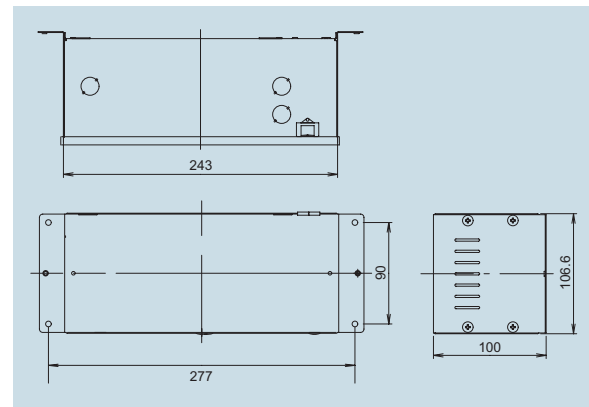

Specifications

Power Supply	50-60Hz 220-240V
Power Consumption (W)	2.9
Fuse Capacity	3A
Dimensions (H X W X D) (mm)	100 X 288 X 110
Weight (g)	1,300

Signal Amplifier

UTR-YRPC

- This unit allows the connection of the following number of units:
 - (1) Transmission Line : Max. 2,000m
 - (2) Connectable Units : Max. Indoor Unit : 400 units
Max. Outdoor Unit : 100 units
Max. Central Remote Controller : 16 units
- Up to 8 signal amplifiers can be installed in a single VRF system.
- A signal amplifier is required,
 - (1) When the total wiring length of the transmission line exceeds 500m.
 - (2) When the total number of units on the transmission line exceeds 64.



Installation example

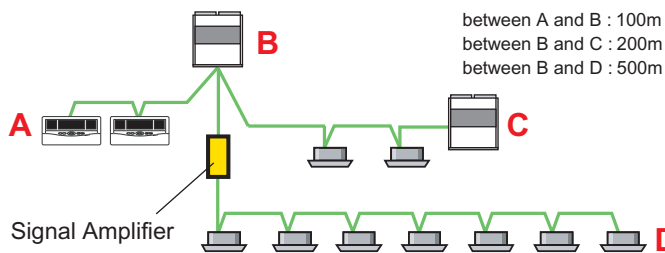

Dimensions

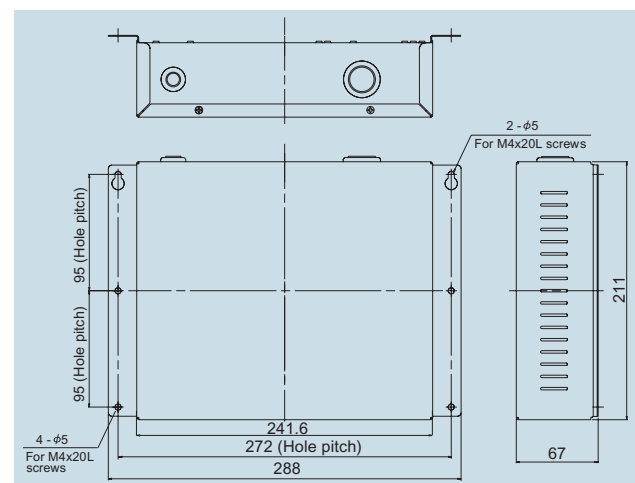

Specifications

Power Supply	50-60Hz 220-240V
Power Consumption (W)	4.5
Dimensions (H X W X D) (mm)	67 X 288 X 211
Weight (g)	1,500

Service Tool Software

UTR-YSTC

Monitored
and controlled
100
outdoor units

Monitored
and controlled
400
indoor units

Extensive monitoring and analysis functions for installation and maintenance

- Operation status can be checked and analyzed to detect even the smallest abnormalities.
- Storage of data on system operation status on a PC allows access even from off site.
- Up to 400 indoor units (a single VRF system) can be controlled and monitored for large scale buildings or hotels.
- This software can be connected to any point of transmission line with USB adaptor (field supplied)



■ Wiring connection

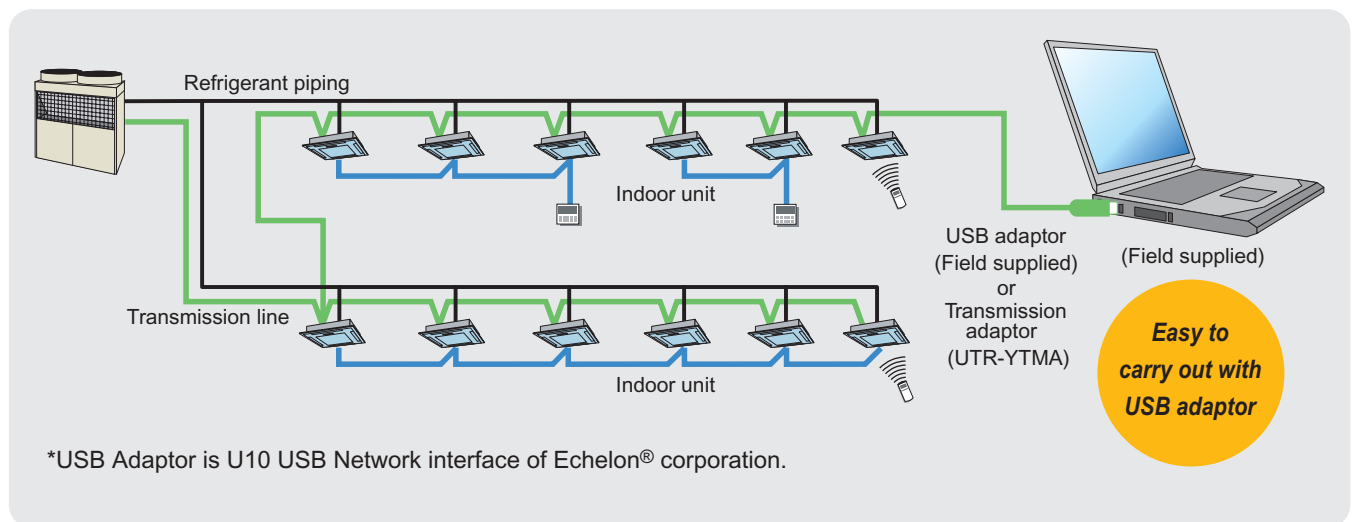

■ Functions

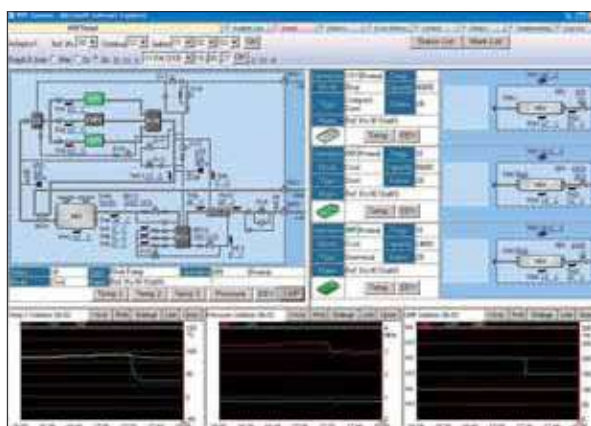

Equipment Detail (Diagram)

Displays the detail information for sensor values, electrical components etc. for the specified units in schematic. The information here can be used along with the detail information in list form, to check the operation status of units and make detail analysis on the cause, in case an error occurs.

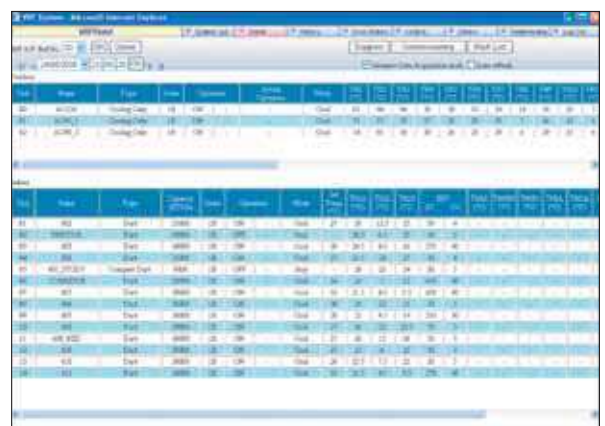

Equipment Detail (List)

Displays the detail information for sensor values, electrical components etc. of units in a specified refrigerant system in list form. The information here can be used along with the detail information in diagram form, to check the operation status of units and make detail analysis on the cause, in case an error occurs.

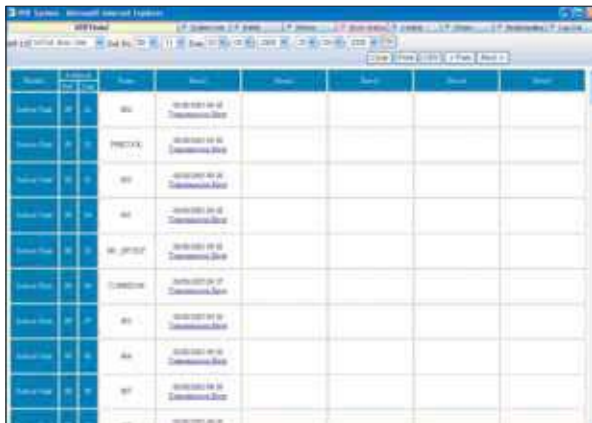

Error History

Displays the error information for each unit. The error information can sequentially be displayed up to 50 items as they occur starting with the latest error.



System List

Displays the overall operation status of all or specified units in the system in a list form.

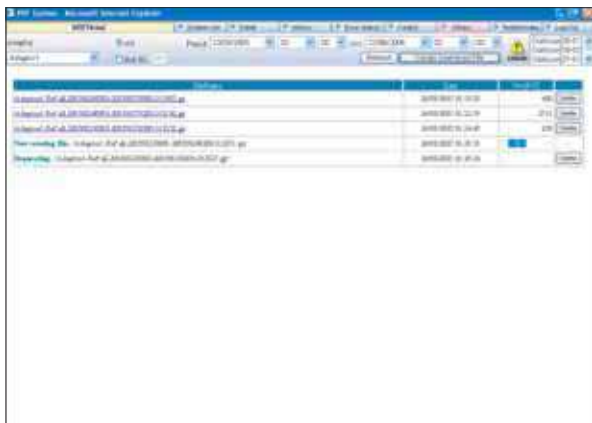

Commissioning Tool

Test run commands can be executed with this tool. During test running, the outdoor unit / indoor unit sensor data can be saved (commissioning log data). After the end of test running, this data can be exported in CSV file format.

Remote File Download

Operation and error history data can be downloaded. Only the required data may be downloaded specifying the refrigerant system, unit and time range.

Requirements of PC for this software

Personal Computer	Operating System	AT compatible machine that runs Microsoft® Windows® Microsoft® Windows® 2000 Professional (English version / Service pack3 or later) Microsoft® Windows® XP Professional (English version / Service pack1 or later)
	CPU	Intel® Pentium® / Celeron®, AMD Athlon™ / Duron™ 1GHz or higher
	HDD	2.1 GB or more
	Memory	256 MB or more
	Interface	Serial port and USB port
Software	Internet Explorer 6.0 or later / Adobe® Acrobat® Reader 4.0 or later	
Hardware	Interlink cable D-sub 9 Pin [Field supplied] or USB Adaptor is U10 USB Network Transmission Adaptor (UTR-YTMA) or interface of Echelon® corporation.	

<PACKING LIST>

Packing List	CD-ROM / Software Protection Key
--------------	----------------------------------

The transmission adaptor or the USB adaptor of optional parts is necessary to connect this software with the VRF system.

Web Monitoring Tool

UTR-YMSA

Software

4
VRF system
can be
supported

1600
Indoor unit
can be
monitored

Product features

- Troubleshooting is performed by monitoring each air conditioning unit remotely during periodical system checks.
- Error notification can be automatically transmitted to several locations using the internet*.
- Requires either a dedicated internet connection* or public telephone line.
- Determination of an error occurrence can be made through error warnings and equipment status information obtained from a remote location.
- The monitoring data in a remote side can be optionally downloaded. And, this data can be displayed in off-line mode of the service tool.
- Monitoring side computer is not required to install special software, required only general web browser.

*Unchanging global IP address is required.

Web Monitoring System

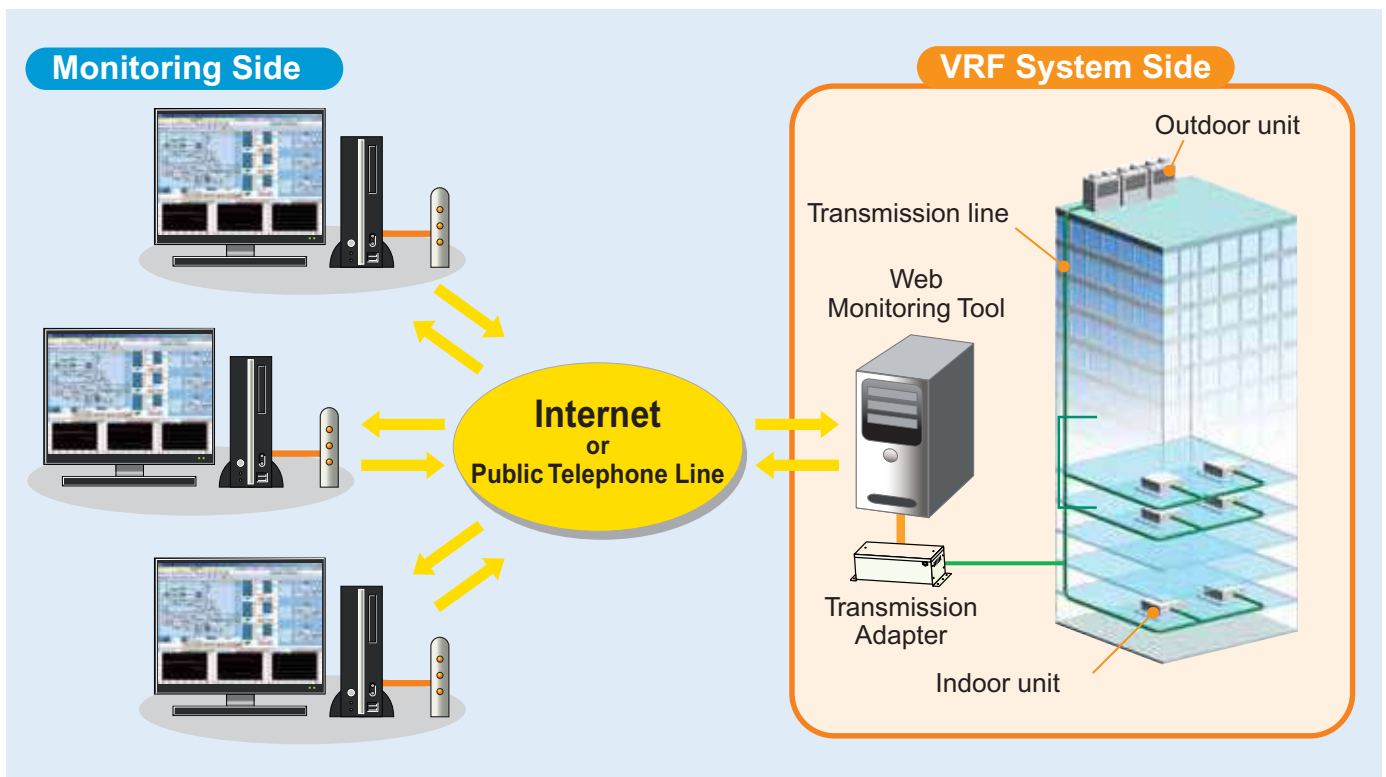

System components

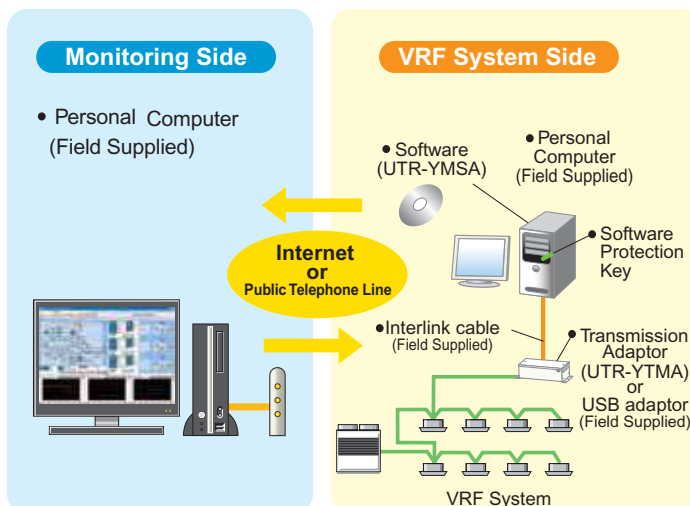

Support 4 VRF system

- PC Transmission adaptors (max. 4 adaptors per PC) permit control and monitoring of up to 1,600 units. Suitable for large-scale buildings or hotels.

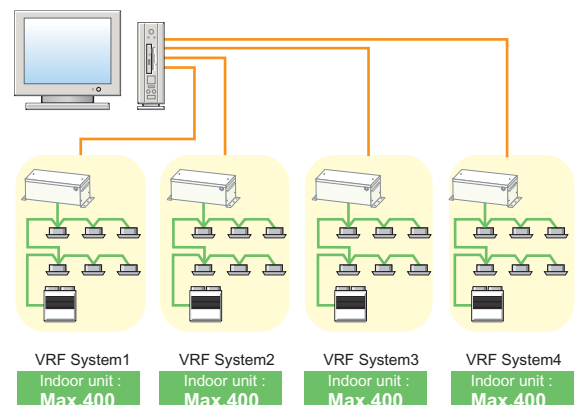

Comparison table

No.	Item	Service Tool UTR-YSTC	Web Monitoring Tool UTR-YMSA	
			Monitoring Side	VRF System Side
1	Interchangeability of equipment	●	●	●
2	Indication of equipment list	●	●	●
3	Operation control	●	—	●
4	Indication of unit circuit diagram	●	●	●
5	Commissioning tool	●	—	●
6	Monitoring of equipment information	●	●	●
7	Monitoring of operating condition	●	●	●
8	Monitoring of sensor data	●	●	●
9	Indication of trend graph	●	●	●
10	Storage and CSV output of operating history (sensor data)	●	●	●
11	Printing of trend graph	●	●	●
12	Monitoring and screen display of abnormalities	●	●	●
13	E-mail automatic transmission of abnormalities	—	—	● *1
14	Setting for user level	—	—	●

*1 It is available only during a connection to the Internet.

Requirements of PC for this software

Personal Computer	Operating System	AT compatible machine that runs Microsoft® Windows® Microsoft® Windows® 2000 Professional (English version / Service pack3 or later) Microsoft® Windows® XP Professional (English version / Service pack1 or later)	
	CPU	Intel® Pentium® / Celeron®, AMD Athlon™/ Duron™ 1GHz or higher	
	HDD	2.1 GB or more	
	Memory	512 MB or more	
	Interface	Serial port (Max. 4) *1and USB port	
Software	Internet Explorer 6.0 or later / Adobe® Acrobat® Reader 4.0 or later *2		
Hardware	Interlink cable D-sub 9 Pin [Field supplied] or USB Adaptor is U10 USB Network Transmission Adaptor (UTR-YTMA) or interface of Echelon® corporation.		

<PACKING LIST>

Packing List	CD-ROM / Software Protection Key
--------------	----------------------------------

*1 1 port required for each VRF system connected.



*2 If Internet Explorer is installed on the remote side PC, remote supervision of VRF system status is available.

The transmission adaptor or the USB adaptor of optional parts is necessary to connect this software with the VRF system.

Outdoor Units

Outdoor Unit Line up

- By combining 6 types (Master Unit and Slave Unit 8/10/14 HP) of 1 to 3 Outdoor Units, ranging from 8 HP (22.4 kW) to 42 HP (120 kW).

Capacity	Model name	
	Master units 	Slave units 
22.4kW (8HP)	AJ*A72LATF	AJ*A72UATF
28.0kW (10HP)	AJ*A90LATF	AJ*A90UATF
40.0kW (14HP)	AJ*126LATF	AJ*126UATF

AJ* : AJY (FUJITSU), AJG (GENERAL)

Capacity range



HP	Capacity (kW)	Maximum connectable indoor unit	Indoor unit connectable capacity (kW)	
8	22.4	15	11.2-33.6	*1 *2 50-150%
10	28.0	16	14.0-42.0	
14	40.0		20.0-60.0	
16	44.8	30	22.4-67.2	*1 50-150%
18	50.4	32	25.2-75.6	
20	56.0		28.0-84.0	
22	62.4		31.2-93.6	
24	68.0		34.0-102	
26	72.8		36.4-109	
28	80.0		40.0-120	
30	84.0	48	42.0-126	
32	90.4		45.2-135	
34	96.0		48.0-144	
36	102		51.0-153	
38	108		54.0-162	
42	120		60.0-180	

*1 Based on rated cooling capacity.

*2 Indoor unit connectable capacity is 75 to 150% for single outdoor unit system (8 - 14HP) in case of including indoor unit model code 18 and under in the system.

*3 Minimum connectable indoor unit number is 2.
However ARXC90 can be used single connection.

Combination of outdoor units

Unit	HP	Capacity (kW)	Master	Slave1	Slave2
	8	22.4	AJ*A72LATF	—	—
	10	28.0	AJ*A90LATF	—	—
	14	40.0	AJ*126LATF	—	—
	16	44.8	AJ*A72LATF	AJ*A72UATF	—
	18	50.4	AJ*A90LATF	AJ*A72UATF	—
	20	56.0	AJ*A90LATF	AJ*A90UATF	—
	22	62.4	AJ*126LATF	AJ*A72UATF	—
	24	68.0	AJ*126LATF	AJ*A90UATF	—
	28	80.0	AJ*126LATF	AJ*126UATF	—
	26	72.8	AJ*A90LATF	AJ*A72UATF	AJ*A72UATF
	30	84.0	AJ*A90LATF	AJ*A90UATF	AJ*A90UATF
	32	90.4	AJ*126LATF	AJ*A90UATF	AJ*A72UATF
	34	96.0	AJ*126LATF	AJ*A90UATF	AJ*A90UATF
	36	102	AJ*126LATF	AJ*126UATF	AJ*A72UATF
	38	108	AJ*126LATF	AJ*126UATF	AJ*A90UATF
	42	120	AJ*126LATF	AJ*126UATF	AJ*126UATF

AJ* : AJY (FUJITSU), AJG (GENERAL)

Specifications

Nominal system capacity	HP	8	10	14	16	18	20	22	
Model name		AJ*A72LATF	AJ*A90LATF	AJ*126LATF	AJ*A72LATF AJ*A72UATF	AJ*A90LATF AJ*A72UATF	AJ*A90LATF AJ*A90UATF	AJ*126LATF AJ*A72UATF	
Power source		3Phase 380-415V 50Hz							
Capacity	Cooling	kW	22.4	28.0	40.0	44.8	50.4	56.0	62.4
	Heating	kW	25.0	31.5	45.0	50.0	56.5	63.0	70.0
Input power	Cooling	kW	7.00	8.75	13.3	14.0	15.8	17.5	20.3
	Heating	kW	6.76	8.51	13.2	13.5	15.3	17.0	20.0
Heat exchanger fin		Blue fin	Blue fin	Blue fin	Blue fin	Blue fin	Blue fin	Blue fin	
Airflow rate	m ³ /h	10700	10700	10800	10700 x 2	10700 x 2	10700 x 2	10800+10700	
Sound pressure level	Cooling	dB (A)	58	58	60	61	61	61	62
	Heating	dB (A)	60	60	62	63	63	63	64
Compressor motor output	kW	3.0 + 4.6	3.0 + 4.6	3.0 + 4.6 + 4.6	3.0 + 4.6 / 3.7 + 3.7	3.0 + 4.6 / 3.7 + 3.7	3.0 + 4.6 / 4.6 + 4.6	3.0 + 4.6 + 4.6 / 3.7 + 3.7	
Dimensions H x W x D	mm	1500 x 1300 x 650	1500 x 1300 x 650	1500 x 1300 x 650	1500 x 1300 x 650 /1500 x 1300 x 650	1500 x 1300 x 650 /1500 x 1300 x 650	1500 x 1300 x 650 /1500 x 1300 x 650	1500 x 1300 x 650 /1500 x 1300 x 650	
Weight	kg	269	269	374	269 + 272	269 + 272	269 + 272	374 + 272	
Refrigerant charge	kg	14.0	14.0	15.5	14.0 + 14.0	14.0 + 14.0	14.0 + 14.0	15.5 + 14.0	
Connection pipe diameter	Liquid	mm	ø12.70	ø12.70	ø12.70	ø12.70	ø15.88	ø15.88	ø15.88
	Gas	mm	ø22.22	ø22.22	ø28.58	ø28.58	ø28.58	ø28.58	ø34.92
Operation temperature range	Cooling	°C	-15 to 43	-15 to 43	-15 to 43	-5 to 43	-5 to 43	-5 to 43	-5 to 43
	Heating	°C	-20 to 21	-20 to 21	-20 to 21	-20 to 21	-20 to 21	-20 to 21	-20 to 21

Note : Specifications are based on the following conditions.

Cooling : Indoor temperature of 27°CDB / 19°CWB, and outdoor temperature of 35°CDB / 24°CWB.

Heating : Indoor temperature of 20°CDB / (15°CWB), and outdoor temperature of 7°CDB / 6°CWB.

Pipe length : 7.5m; Height difference between outdoor unit and indoor unit : 0m.

■ Dimensions

- Master unit and slave unit are same dimensions.

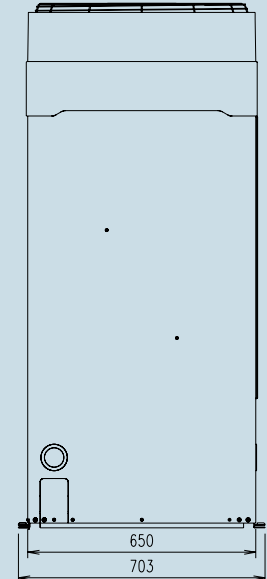
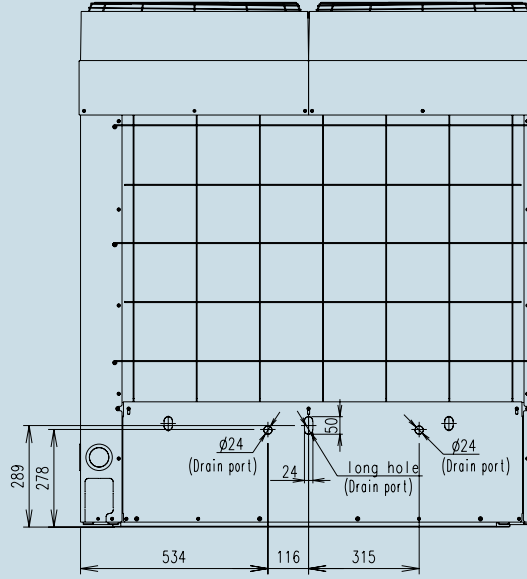
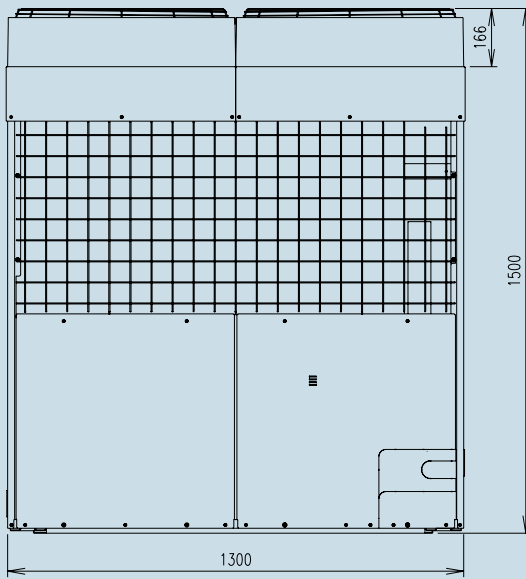
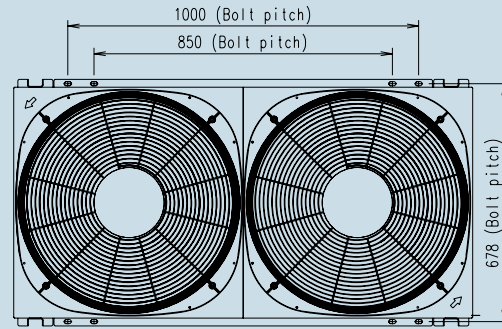











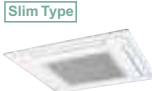













24	26	28	30	32	34	36	38	42
AJ*126LATF AJ*A90UATF	AJ*A90LATF AJ*A72UATF AJ*A72UATF	AJ*126LATF AJ*126UATF	AJ*A90LATF AJ*A90UATF AJ*A90UATF	AJ*126LATF AJ*A90UATF AJ*A72UATF	AJ*126LATF AJ*A90UATF AJ*A90UATF	AJ*126LATF AJ*126UATF AJ*A72UATF	AJ*126LATF AJ*126UATF AJ*A90UATF	AJ*126LATF AJ*126UATF
3Phase 380-415V 50Hz								
68.0	72.8	80.0	84.0	90.4	96.0	102	108	120
76.5	81.5	90.0	94.5	102	108	115	122	135
22.1	22.8	26.7	26.3	29.1	30.8	33.7	35.4	40.0
21.7	22.0	26.5	25.5	28.5	30.3	33.2	35.0	39.7
Blue fin	Blue fin	Blue fin	Blue fin	Blue fin	Blue fin	Blue fin	Blue fin	Blue fin
10800+10700	10700 x 3	10800 x 2	10700 x 3	10800+10700 x 2	10800+10700 x 2	10800 x 2+10700	10800 x 2+10700	10800 x 3
62	62	62	62	63	63	63	64	64
64	64	64	64	65	65	65	66	66
3.0 + 4.6 + 4.6 / 4.6 + 4.6	3.0 + 4.6 / 3.7 + 3.7 / 3.7 + 3.7	3.0 + 4.6 + 4.6 / 4.6 + 4.6 + 4.6	3.0 + 4.6 / 4.6 + 4.6 / 4.6 + 4.6	3.0 + 4.6 + 4.6 / 4.6 + 4.6 / 3.7 + 3.7	3.0 + 4.6 + 4.6 / 4.6 + 4.6 / 4.6 + 4.6	3.0 + 4.6 + 4.6 / 4.6 + 4.6 + 4.6 / 3.7 + 3.7	3.0 + 4.6 + 4.6 / 4.6 + 4.6 + 4.6 / 4.6 + 4.6	3.0 + 4.6 + 4.6 / 4.6 + 4.6 + 4.6 / 4.6 + 4.6 + 4.6
1500 x 1300 x 650 /1500 x 1300 x 650	1500 x 1300 x 650 /1500 x 1300 x 650 /1500 x 1300 x 650	1500 x 1300 x 650 /1500 x 1300 x 650	1500 x 1300 x 650 /1500 x 1300 x 650 /1500 x 1300 x 650	1500 x 1300 x 650 /1500 x 1300 x 650 /1500 x 1300 x 650	1500 x 1300 x 650 /1500 x 1300 x 650 /1500 x 1300 x 650	1500 x 1300 x 650 /1500 x 1300 x 650 /1500 x 1300 x 650	1500 x 1300 x 650 /1500 x 1300 x 650 /1500 x 1300 x 650	1500 x 1300 x 650 /1500 x 1300 x 650 /1500 x 1300 x 650
374 + 272	269 + 272 + 272	374 + 377	269 + 272 + 272	374 + 272 + 272	374 + 272 + 272	374 + 377 + 272	374 + 377 + 272	374 + 377 + 377
15.5 + 14.0	14.0 + 14.0 + 14.0	15.5 + 15.5	14.0 + 14.0 + 14.0	15.5 + 14.0 + 14.0	15.5 + 14.0 + 14.0	15.5 + 15.5 + 14.0	15.5 + 15.5 + 14.0	15.5 + 15.5 + 15.5
ø15.88	ø15.88	ø15.88	ø19.05	ø19.05	ø19.05	ø19.05	ø19.05	ø19.05
ø34.92	ø34.92	ø34.92	ø34.92	ø34.92	ø34.92	ø41.27	ø41.27	ø41.27
-5 to 43	-5 to 43	-5 to 43	-5 to 43	-5 to 43	-5 to 43	-5 to 43	-5 to 43	-5 to 43
-20 to 21	-20 to 21	-20 to 21	-20 to 21	-20 to 21	-20 to 21	-20 to 21	-20 to 21	-20 to 21

Indoor Units

Indoor unit capacity range						
Capacity range(kW)	2.2	2.8	3.6	4.05	5.3	5.7
Type	7	9	12	14	18	20
Compact Cassette P42	 AUXB07LATF	 AUXB09LATF	 AUXB12LATF	 AUXB14LATF	 AUXB18LATF	
Slim Type Cassette P44						Slim Type  AU*A20LATF
Silent model Compact Duct P46	 ARXB07LALF	 ARXB09LALF	 ARXB12LALF	 ARXB14LALF	 ARXB18LALF	
Silent model Low Static Pressure Duct P48						
Duct P48						
High Static Pressure Duct P50						
Floor / Ceiling P52			 AB*A12LATF	 AB*A14LATF	 AB*A18LATF	
Ceiling P54						
Comfort model Compact Wall Mounted P56	 AS*E07LACF	 AS*E09LACF	 AS*E12LACF	 AS*E14LACF		
	With this model, connection of EV kit is necessary.					
Wall Mounted P58					 AS*A18LATF	
Ceiling Wall P60	 AW*A07LATF	 AW*A09LATF	 AW*A12LATF	 AW*A14LATF	 AW*A18LATF	

•AU*: AUY(FUJITSU), AUG(GENERAL) •AB*: ABY(FUJITSU), ABG(GENERAL) •AS*: ASY(FUJITSU), ASG(GENERAL) •AW*: AWY(FUJITSU), AWG(GENERAL)

Broad range of indoor units of many designs and capacity ranges available which can be selected to suit any air conditioning needs

6.8 24	7.05 25	8.8 30	10.5 36	12.7 45	14.1 54	17.0 60	25.4 90
	 AU*A25LATF	 AU*A30LATF	 AU*A36LATF	 AU*A45LATF	 AU*A54LATF		
	 ARXB25LATF	 ARXB30LATF	 ARXB36LATF	 ARXB45LATF			
	 ARXA25LATF	 ARXA30LATF	 ARXA36LATF	 ARXA45LATF			
			 ARXC36LATF	 ARXC45LATF		 ARXC60LATF	 ARXC90LATF
 AB*A24LATF							
		 AB*A30LATF	 AB*A36LATF	 AB*A45LATF	 AB*A54LATF		
 AS*A24LATF		 AS*A30LATF					
 AW*A24LATF		 AW*A30LATF					

Compact Cassette

Compact size panel design
that fits standard ceiling panel (600x600mm)

Models

- AUXB07LATF
- AUXB09LATF
- AUXB12LATF
- AUXB14LATF
- AUXB18LATF



Comfortable air flow 4-step swing

Auto air flow direction and auto swing

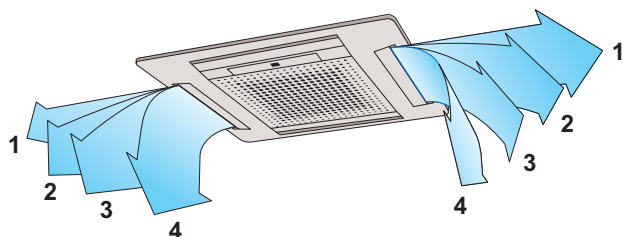

2-4 way air flow system

Select 2-way, 3-way or 4-way air flow to suit your needs.



Specifications

Model name			AUXB07LATF	AUXB09LATF	AUXB12LATF	AUXB14LATF	AUXB18LATF
Power source			220 to 240V 50Hz				
Capacity	Cooling	kW	2.20	2.80	3.60	4.00	5.00
	Heating		2.50	3.20	4.10	4.50	5.45
Input power			28	28	52	52	50
Airflow rate	High	m ³ /h	530	530	580	580	640
	Med		480	480	520	520	540
	Low		410	410	460	460	470
Sound pressure level	High	dB(A)	38	38	41	41	44
	Med		35	35	37	37	38
	Low		31	31	34	34	35
Dimensions (H x W x D)			mm 230 x 570 x 570	mm 230 x 570 x 570	mm 230 x 570 x 570	mm 230 x 570 x 570	mm 230 x 570 x 570
Weight			kg 18	kg 18	kg 18	kg 18	kg 18
Refrigerant pipe diameter	Liquid (Flare)	mm	ø6.35	ø6.35	ø6.35	ø6.35	ø9.52
	Gas (Flare)		ø12.7	ø12.7	ø12.7	ø12.7	ø15.88
Grille			UTG-UD*D-W (Option)				

※UTG-UDYD-W(FUJITSU); UTG-UDGD-W(GENERAL)

Note : Specifications are based on the following conditions.

Cooling : Indoor temperature of 27°CDB / 19°CWB, and outdoor temperature of 35°CDB / 24°CWB.

Heating : Indoor temperature of 20°CDB / (15°CWB), and outdoor temperature of 7°CDB / 6°CWB.

Pipe length : 7.5 m; Height difference between outdoor unit and indoor unit : 0 m.

Voltage : 230 [V].

■ Compact size

Compact grille that fits standard ceiling panel (600mm x 600mm)

Punch Hole Grille

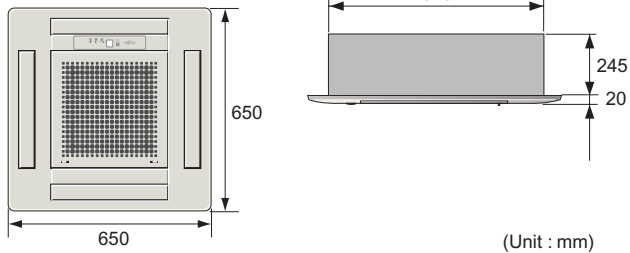

(Unit : mm)

■ Condensate pump lift to 400mm

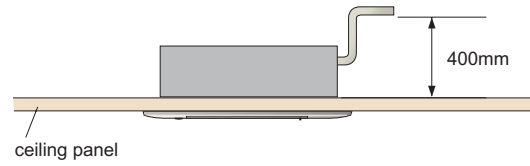

■ Low noise

Large airflow and reduced noise output achieved by the use of a large diameter variable pitch turbo fan.

7 blades fan

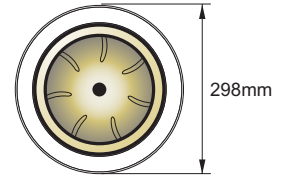

■ Easy maintenance

By placing the electrical component box inside the unit easy maintenance is assured.

Wide opening for easy maintenance.

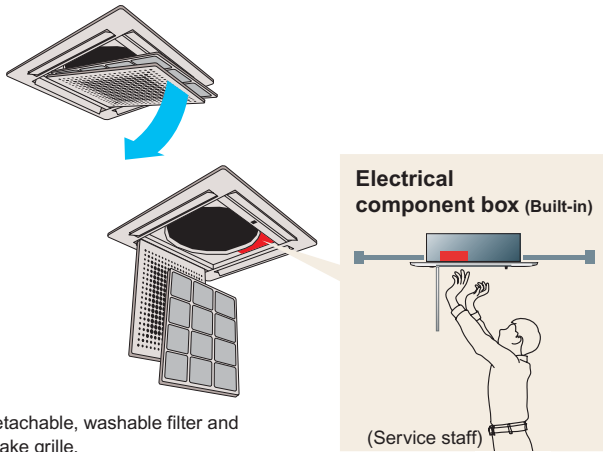

Detachable, washable filter and intake grille.

■ Draft prevention

Movement of the flap angle can be changed via a simple switch during installation, thereby preventing uncomfortable drafts.

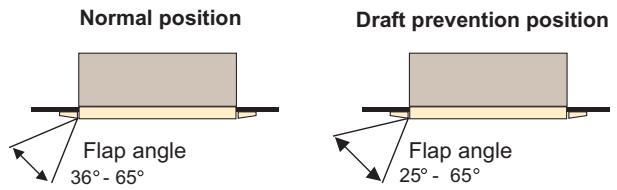

Dimensions

Models: AUXB07 / AUXB09 / AUXB12 / AUXB14 / AUXB18

(Unit : mm)

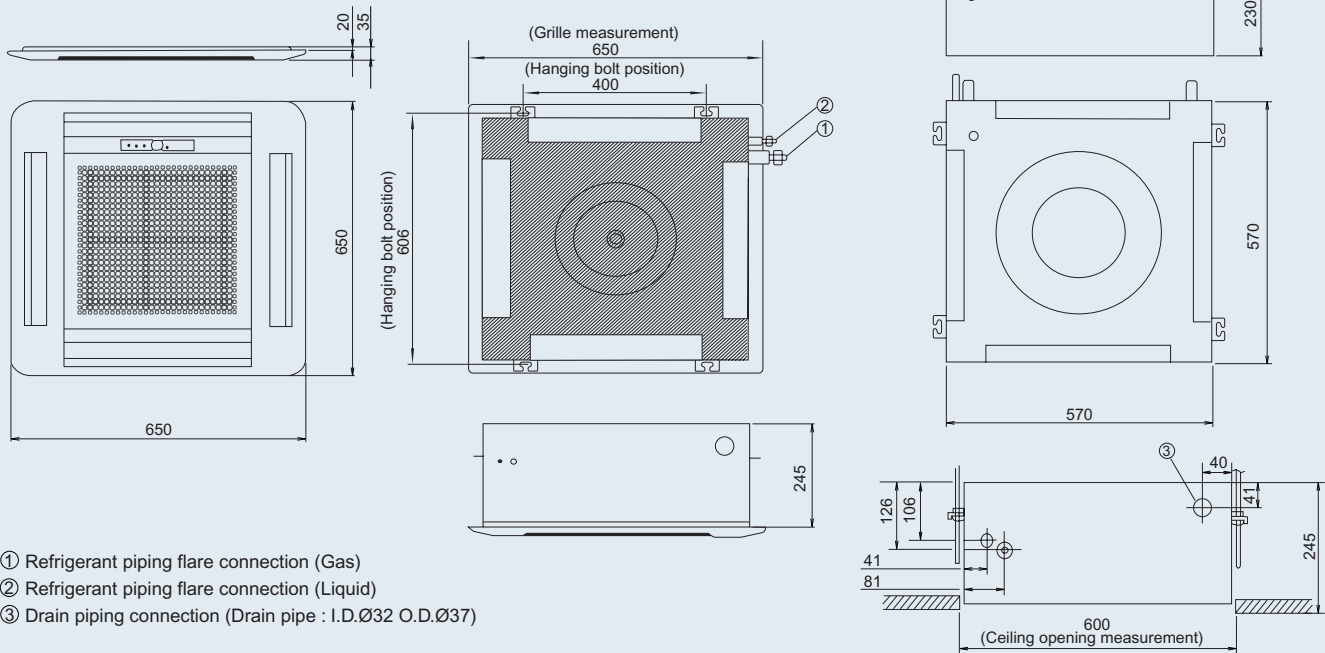

- ① Refrigerant piping flare connection (Gas)
- ② Refrigerant piping flare connection (Liquid)
- ③ Drain piping connection (Drain pipe : I.D.Ø32 O.D.Ø37)

Cassette Slim Type

Unit fascia can be adjusted up to 35mm to enable installation in a narrow ceiling

Models

AU*A20LATF
AU*A25LATF
AU*A30LATF



Cassette

Detachable grille makes filter maintenance easy

Models

AU*A36LATF
AU*A45LATF
AU*A54LATF



Comfortable air flow

4 step swing

Auto air flow direction and auto swing

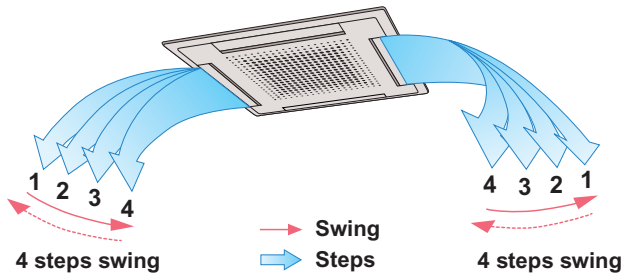

2-4 way air flow system

Select 2-way, 3-way or 4-way air flow to suit your needs.

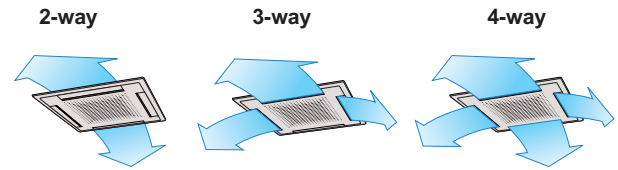

Wide air flow

Larger air flap distributes the outlet air flow a longer distance in the horizontal direction.

Specifications

Model name			AU*A20LATF	AU*A25LATF	AU*A30LATF	AU*A36LATF	AU*A45LATF	AU*A54LATF
Power source			220 to 240V 50Hz					
Capacity	Cooling	kW	5.70	7.05	8.80	10.5	12.7	14.1
	Heating		5.80	7.85	9.10	12.7	13.7	15.8
Input power		W	104	124	140	175	190	219
Airflow rate	High	m ³ /h	1,000	1,100	1,250	1,500	1,550	1,700
	Med		840	940	1,050	1,300	1,350	1,420
	Low		700	780	840	1,100	1,100	1,200
Sound pressure level	High	dB(A)	41	43	46	47	48.5	51.5
	Med		37	40	43	42.5	46	47.5
	Low		33	35	37	38	41	43.5
Dimensions (H x W x D)	(Main body)	mm	246 x 830 x 830	246 x 830 x 830	246 x 830 x 830	296 x 830 x 830	296 x 830 x 830	296 x 830 x 830
	(With Panel)		265 x 940 x 940	265 x 940 x 940	265 x 940 x 940	315 x 940 x 940	315 x 940 x 940	315 x 940 x 940
Weight		kg	34	34	34	40	40	40
Refrigerant pipe diameter	Liquid (Flare)	mm	ø9.52	ø9.52	ø9.52	ø9.52	ø9.52	ø9.52
	Gas (Flare)		ø15.88	ø15.88	ø15.88	ø19.05	ø19.05	ø19.05

※ AU*: AUY(FUJITSU), AUG(GENERAL)

Note : Specifications are based on the following conditions.

Cooling : Indoor temperature of 27°CDB / 19°CWB, and outdoor temperature of 35°CDB / 24°CWB.

Heating : Indoor temperature of 20°CDB / (15°CWB), and outdoor temperature of 7°CDB / 6°CWB.

Pipe length : 7.5 m; Height difference between outdoor unit and indoor unit : 0 m.

Voltage : 230 [V].

Flexible installation

Compact body ensures space saving installation.
A slender fit option is available where ceiling void space is limited.

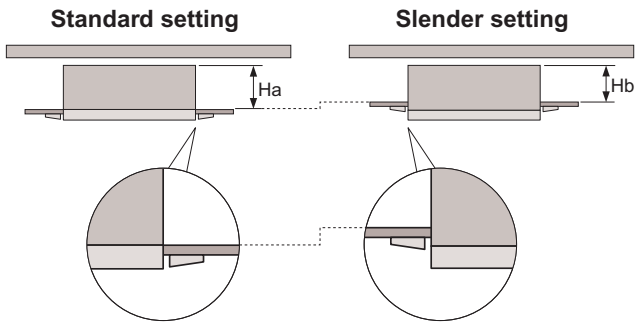

	Standard setting	Slender setting
	Ha	Hb
AU20 / AU25 / AU30	235	200
AU36 / AU45 / AU54	285	250

(Unit : mm)

Easy maintenance

The control box is easily accessible for maintenance work.
Wide opening for easy access.

Detachable, washable filter and intake grille.

Wide opening and long-life filter.

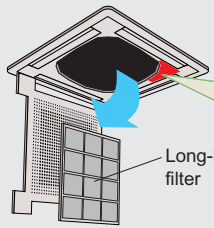

Long-life filter

Long-life filter

High efficiency, long-life filter extends the cleaning cycle.

By placing the electrical component box inside the unit easy maintenance is assured.

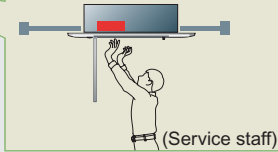

(Service staff)

Draft prevention

Movement of the flap angle can be changed via a simple switch during installation, thereby preventing uncomfortable drafts.

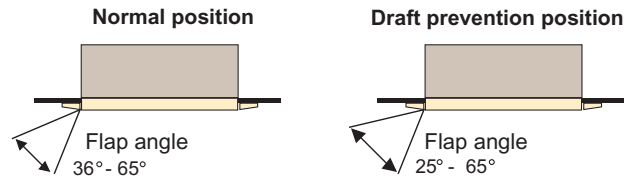

Duct connection hole opening

Fresh air can be introduced through this opening.

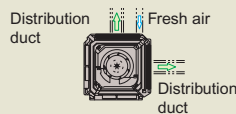

Conditioned air can be distributed by means of a distribution duct.

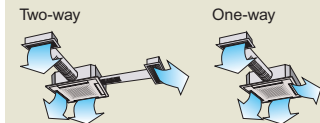

Improved noise level and air distribution

Noise output has been dramatically lowered.

- Improved turbo fan shape (aerodynamic design)
- Expanded air distribution
- Low internal resistance Molded fan motor

Condensate pump lift to 800mm

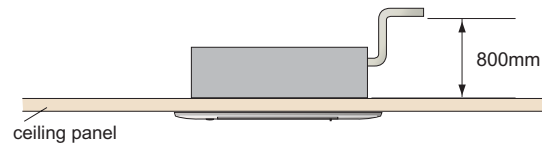

Dimensions

Models: AU*A20 / AU*A25 / AU*A30 (Slim type)
AU*A36 / AU*A45 / AU*A54

(Unit : mm)

() : AU20 / AU25 / AU30

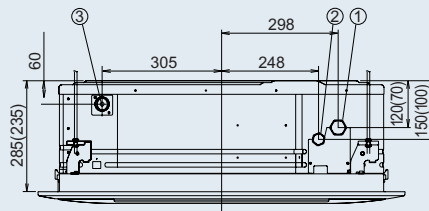
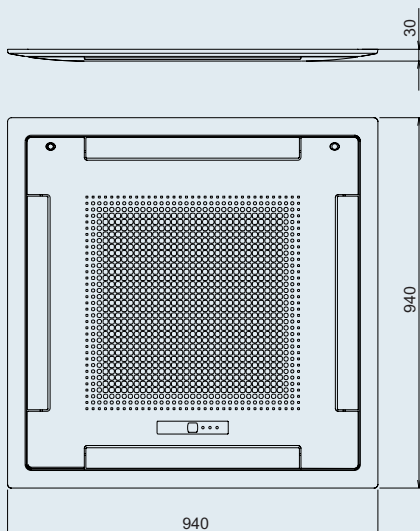

- ① Refrigerant piping flare connection (Gas)
- ② Refrigerant piping flare connection (Liquid)
- ③ Drain piping connection
(Drain pipe : I.D.Ø32 O.D.Ø37)

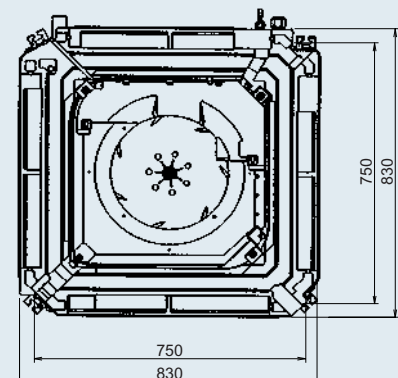
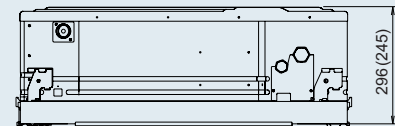
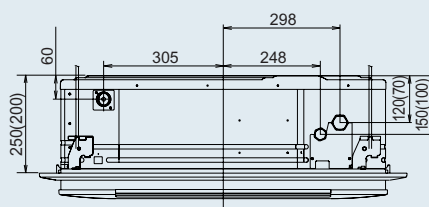

Compact Duct Silent model

Small and compact indoor unit suitable for many applications

Models

ARXB07LALF
ARXB09LALF



Models

ARXB12LALF
ARXB14LALF
ARXB18LALF



Low noise level

A low noise level has been achieved for each capacity

Model		7	9	12	14	18
Static pressure (Normal/Max.)	Pa	0 / 50				
Noise level (Low speed)	dB(A)	24	27	25	26	30

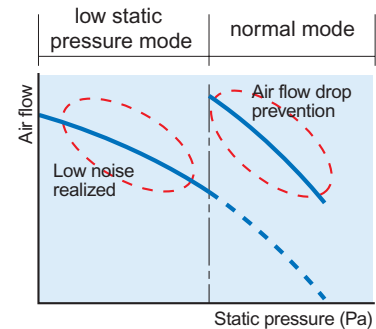

Specifications

Model name			ARXB07LALF	ARXB09LALF	ARXB12LALF	ARXB14LALF	ARXB18LALF
Power source			220 to 240V 50Hz				
Capacity	Cooling	kW	2.20	2.80	3.60	4.00	5.30
	Heating	kW	2.50	3.20	4.10	4.80	5.60
Input power		W	31.2	32.6	55.0	63.0	103.0
Airflow rate	High	m ³ /h	330	370	560	610	950
	Med		300	340	500	550	790
	Low		270	310	420	470	620
Static pressure range		Pa	0 to 50	0 to 50	0 to 50	0 to 50	0 to 50
Sound pressure level	High	dB(A)	29	31	30	31	40
	Med		27	29	28	29	35
	Low		24	27	25	26	30
Dimensions (H x W x D)		mm	217 x 663 x 595	217 x 663 x 595	217 x 953 x 595	217 x 953 x 595	217 x 953 x 595
Weight		kg	18	18	25	25	25
Connection pipe diameter	Liquid (Flare)	mm	ø6.35	ø6.35	ø6.35	ø6.35	ø9.52
	Gas (Flare)	mm	ø12.7	ø12.7	ø12.7	ø12.7	ø15.88

Note : Specifications are based on the following conditions.

Cooling : Indoor temperature of 27°CDB / 19°CWB, and outdoor temperature of 35°CDB / 24°CWB.

Heating : Indoor temperature of 20°CDB / (15°CWB), and outdoor temperature of 7°CDB / 6°CWB.

Pipe length : 7.5 m; Height difference between outdoor unit and indoor unit : 0 m.

Voltage : 230 [V]; Standard static pressure : 0 Pa.

■ Compact design

Ultra-slim duct air conditioner for easy installation

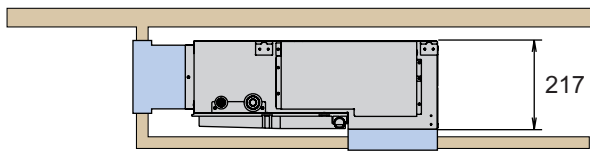

Slim size (217mm) allows installation even where the space behind the ceiling is narrow.

■ Two-direction drain piping

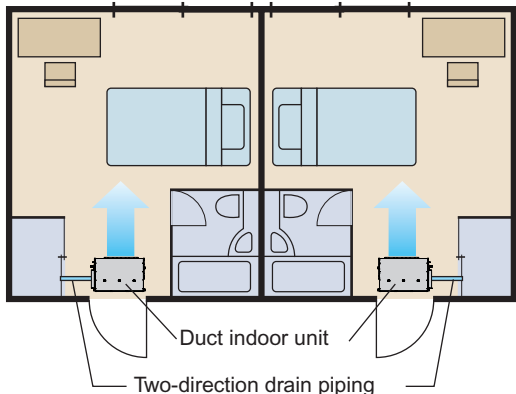

■ Air-intake

Air intake direction can be selected to match the installation site.

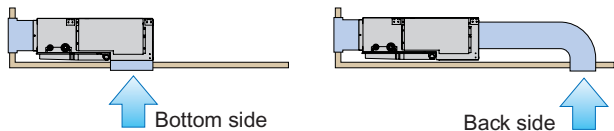

■ Flexible installation

Ceiling concealed

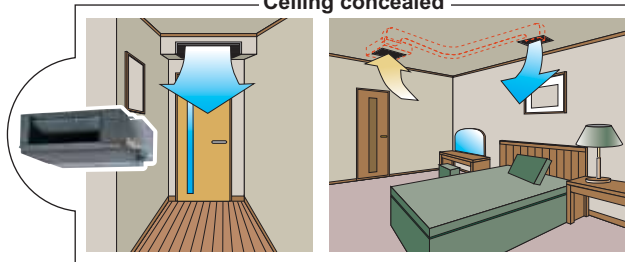

Floor concealed

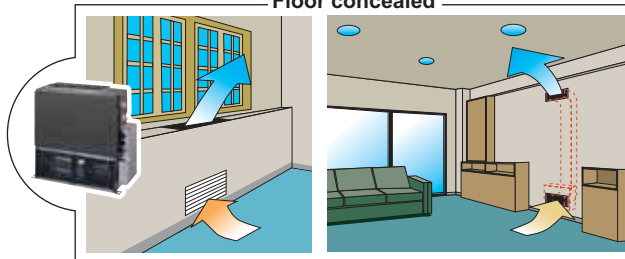

■ Filter (Accessory)

ARXB07 / ARXB09

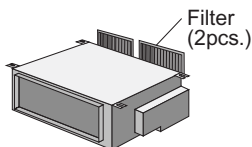

ARXB12 / ARXB14 / ARXB18

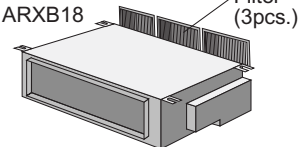

■ Optional parts

Remote sensor unit UTD-RS100
IR receiver unit UTB-YWA

Dimensions

Models: ARXB07 / ARXB09 / ARXB12 / ARXB14 / ARXB18

*Service accessibility must be allowed for when installing the product.
Please consult the installation manual for the necessary service access size.

(Unit : mm)

() : AR7 / AR9

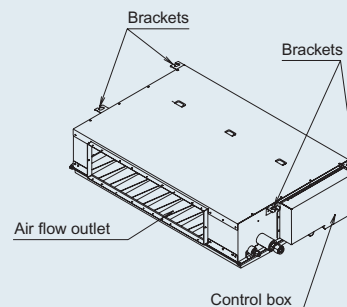
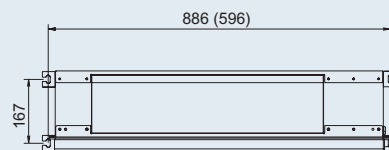
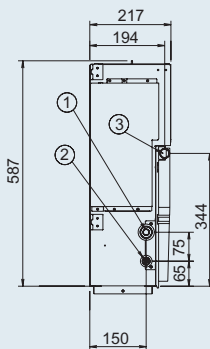
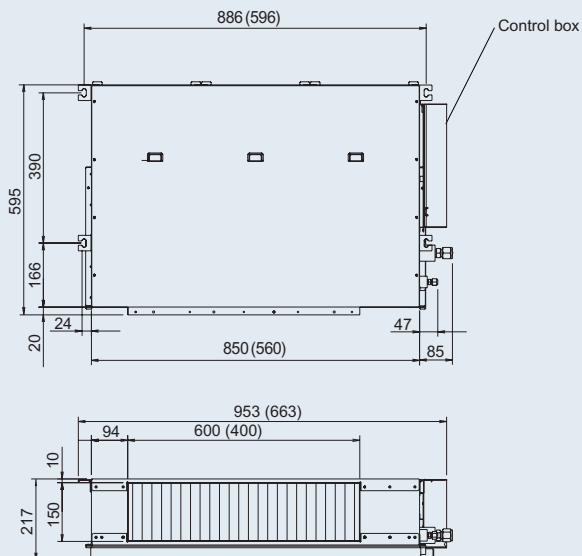

- ① Refrigerant piping flare connection (Gas)
- ② Refrigerant piping flare connection (Liquid)
- ③ Drain piping connection (Drain pipe : I.D.Ø21.5 O.D.Ø26.0)

Low Static Pressure Duct

Silent model

Indoor units suitable for quiet rooms such as a hotel or a bedroom

Models

ARXB25LATF
ARXB30LATF
ARXB36LATF
ARXB45LATF



Duct

Slim Compact design allows for easy installation in narrow ceiling spaces up to 270mm

Models

ARXA25LATF
ARXA30LATF
ARXA36LATF
ARXA45LATF



■ Slim & Compact design

In the case of bottom suction type, not only does the design allow for installation in narrow ceiling space up to 270mm, further space requirements have been guaranteed by placing the control box inside the chassis.

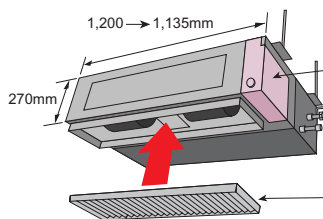

Control box is now included as part of the main chassis

One touch operating and easy to install long life filter (Optional Parts)

Specifications

Model name			ARXB25LATF	ARXB30LATF	ARXB36LATF	ARXB45LATF	ARXA25LATF	ARXA30LATF	ARXA36LATF	ARXA45LATF
Power source			220 to 240V 50Hz							
Capacity	Cooling	kW	7.00	8.80	10.5	12.7	7.00	8.80	10.5	12.7
	Heating	kW	7.70	9.50	12.7	14.3	7.70	9.50	12.7	14.3
Input power		W	155	171	216	246	161	172	220	312
Airflow rate	High	m ³ /h	1,090	1,200	1,440	1,580	1,100	1,400	1,750	1,800
	Med		970	1,090	1,270	1,450	1,000	1,300	1,650	1,600
	Low		870	970	1,160	1,320	900	1,200	1,550	1,500
Static pressure range		Pa	0 to 80	0 to 80	0 to 80	0 to 80	30 to 150	30 to 150	30 to 150	30 to 150
Sound pressure level	High	dB(A)	29	31	35	37	38	40	43	44
	Med		26	28	32	35	36	38	41	42
	Low		24	26	30	33	34	36	39	40
Dimensions (H x W x D)		mm	270x1,135x700	270x1,135x700	270x1,135x700	270x1,135x700	270x1,135x700	270x1,135x700	270x1,135x700	270x1,135x700
Weight		kg	43	43	43	45	43	43	43	45
Connection pipe diameter	Liquid (Flare)	mm	ø9.52	ø9.52	ø9.52	ø9.52	ø9.52	ø9.52	ø9.52	ø9.52
	Gas (Flare)	mm	ø15.88	ø15.88	ø19.05	ø19.05	ø15.88	ø15.88	ø19.05	ø19.05

Note : Specifications are based on the following conditions.

Cooling : Indoor temperature of 27°CDB / 19°CWB, and outdoor temperature of 35°CDB / 24°CWB.

Heating : Indoor temperature of 20°CDB / (15°CWB), and outdoor temperature of 7°CDB / 6°CWB.

Pipe length : 7.5 m; Height difference between outdoor unit and indoor unit : 0 m.

Voltage : 230 [V]; Standard static pressure : 0 Pa (ARXB25LATF, ARXB30LATF, ARXB36LATF, ARXB45LATF)

Voltage : 230 [V]; Standard static pressure : 100 Pa (ARXA25LATF, ARXA30LATF, ARXA36LATF, ARXA45LATF)

Line-up of low-noise and high-power models, compatible with a wide range of static pressure

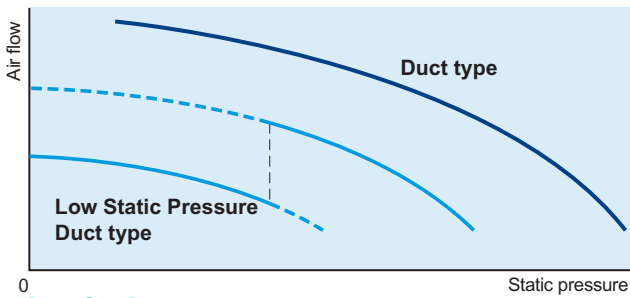

Low Static Pressure Duct type

Optimum model for hotels or bedrooms

An ultra low-noise model that achieves a quiet interior. Perfect for hotels or bedrooms with limited air duct installation space. Two different levels can be selected according to the static pressure range.

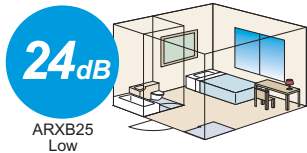

Duct type

Powerful model with a flexible design

With a powerful motor, appropriate for a wide range of static pressure. Flexible air duct installation is possible in a large space such as an office.



Two-direction drain piping

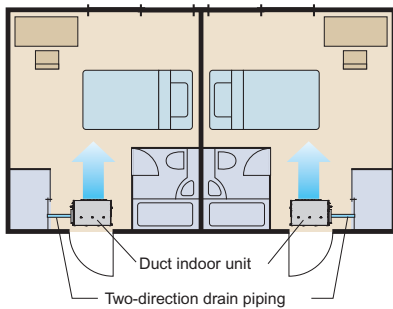

Easy maintenance

See below for the case of rear suction type

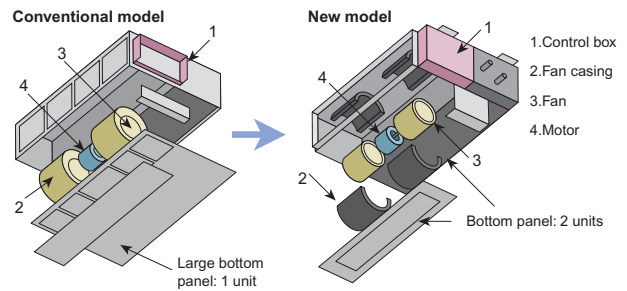

Structural improvement is attained by making the bottom panel two pieces, front and rear, and the internal fan casing is also made dismantlable in two pieces, namely, upper and lower ones. The motor and fan maintenance and dismantling can be made easily by removing the rear panel and lower part of the casing with the main chassis installed.

Installation styles

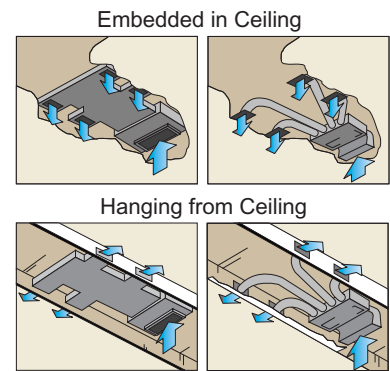

Optional parts

Remote sensor unit	UTD-RS100
Long life filter	UTD-LF25NA
Flange (Square)	UTD-SF045T
Flange (Round)	UTD-RF204
IR receiver unit	UTB-YWA

Dimensions

Models: ARXB25 / ARXB30 / ARXB36 / ARXB45
ARXA25 / ARXA30 / ARXA36 / ARXA45

*Service accessibility must be allowed for when installing the product.

Please consult the installation manual for the necessary service access size.

(Unit : mm)

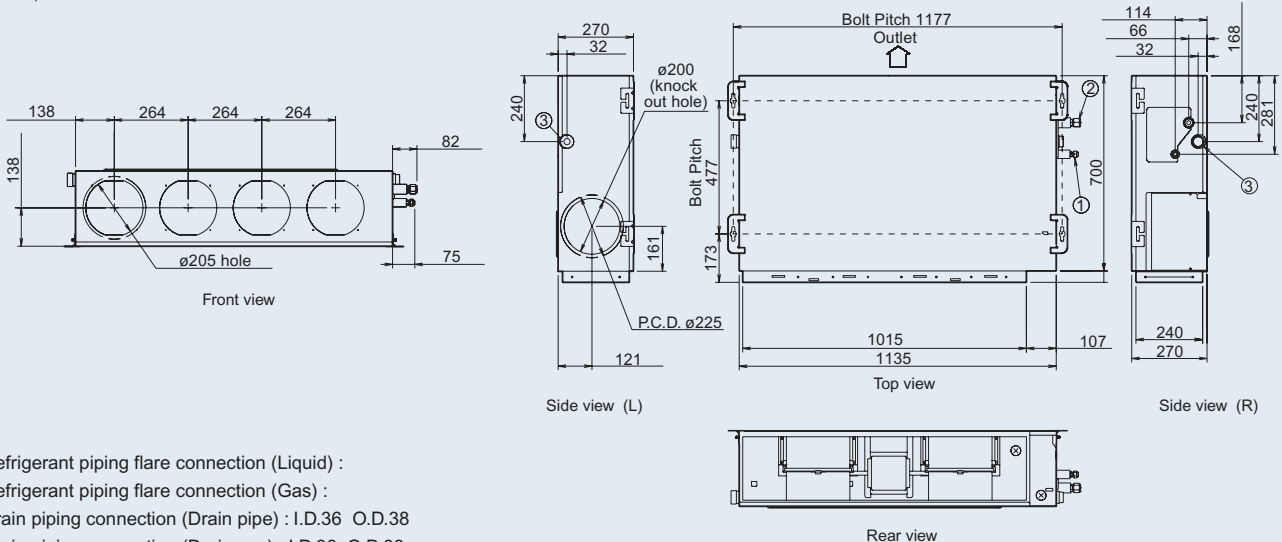

- ① Refrigerant piping flare connection (Liquid) :
- ② Refrigerant piping flare connection (Gas) :
- ③ Drain piping connection (Drain pipe) : I.D.36 O.D.38
- ③ Drain piping connection (Drain cap) : I.D.36 O.D.38

High Static Pressure Duct

These indoor units allow for high airflow quantities

Models

ARXC36LATF
ARXC45LATF
ARXC60LATF



Models

ARXC90LATF



Specifications

Model name			ARXC36LATF	ARXC45LATF	ARXC60LATF	ARXC90LATF
Power source			220 to 240V 50Hz			3Phase 380 to 415V 50Hz
Capacity	Cooling	kW	10.5	12.7	17.0	25.4
	Heating		12.7	14.3	18.2	29.5
Input power		W	405	427	427	970
Airflow rate	High	m ³ /h	2,500	3,500	3,500	3,950
	Med		1,950	3,000	3,000	-
	Low		1,450	2,460	2,460	-
Static pressure range		Pa	100 to 200	100 to 250	100 to 250	100 to 300
Sound pressure level	High	dB(A)	45	49	49	50
	Med		38	45	45	-
	Low		32	42	42	-
Dimensions (H x W x D)		mm	400 x 1,050 x 500	400 x 1,050 x 500	400 x 1,050 x 500	450 x 1,550 x 700
Weight		kg	45	45	50	82
Connection pipe diameter	Liquid	mm	ø9.52(Flare)	ø9.52 (Flare)	ø9.52(Flare)	ø12.7 (Brazing)
	Gas		ø19.05 (Flare)	ø19.05 (Flare)	ø19.05 (Flare)	ø22.22(Brazing)

Note : Specifications are based on the following conditions.

Cooling : Indoor temperature of 27°CDB / 19°CWB, and outdoor temperature of 35°CDB / 24°CWB.

Heating : Indoor temperature of 20°CDB / (15°CWB), and outdoor temperature of 7°CDB / 6°CWB.

Pipe length : 7.5 m; Height difference between outdoor unit and indoor unit : 0 m.

Voltage : 230 [V]; Standard static pressure : 100 Pa (ARXC36LATF, ARXC45LATF, ARXC60LATF).

Voltage : 400 [V]; Standard static pressure : 200 Pa (ARXC90LATF).

Easy installation (Compact size & Lightweight)

By downsizing basic chassis and reducing materials weight, compact size and lightweight are realized.

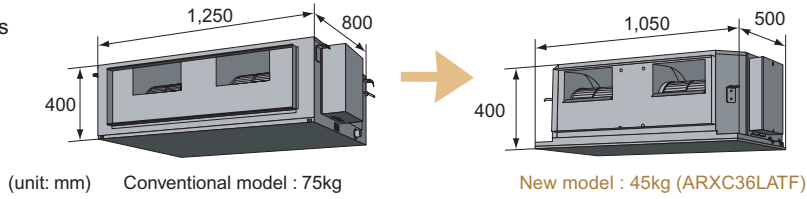

Volume
47.5%
down

Weight
40%
down

Design also corresponding to high static pressure. Model: ARXC90

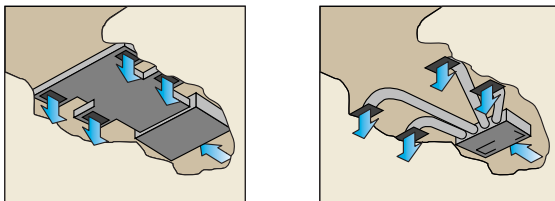

Low noise

Turbulent air flow is reduced by cutting off the corners of conventional indoor unit front panel and fan case.

Conventional model

New model (ARXC36LATF)

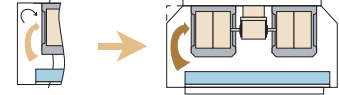

Low noise is realized by adopting plastic case, plastic fan

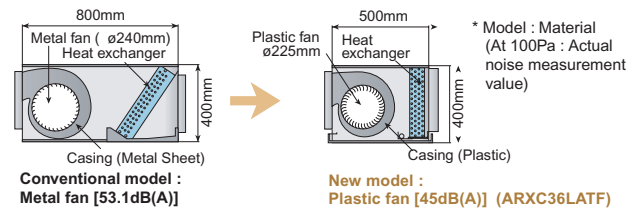

Optional parts

Long-life filter UTD-LF60KA (For ARXC36 / 45 / 60)
IR receiver unit UTB-YWA

Dimensions

Models: ARXC36 / ARXC45 / ARXC60
(Unit : mm)

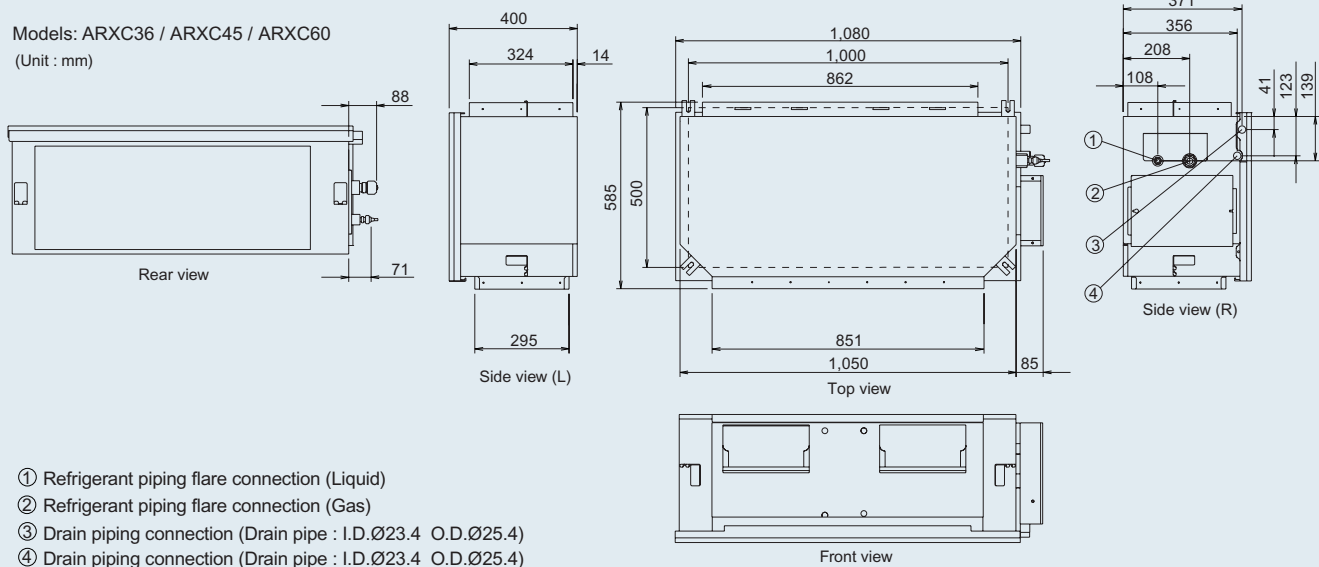

Models: ARXC90
(Unit : mm)

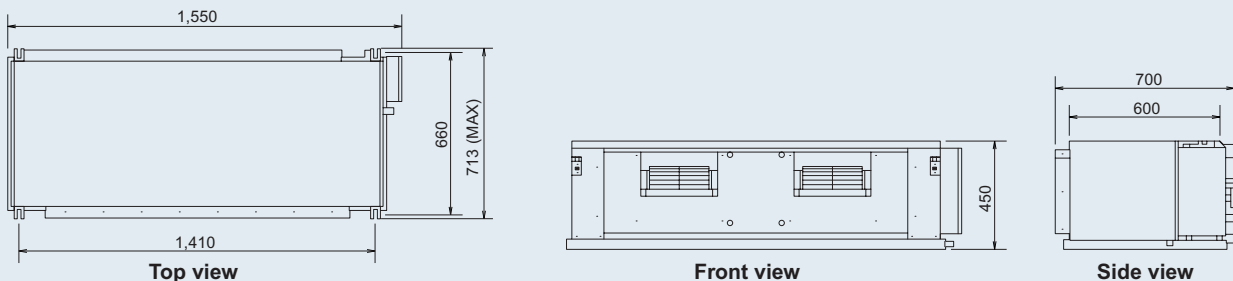

Floor / Ceiling

The slim and lightweight design allows the unit to be suspended from the ceiling or installed on the floor. This type suits many room designs

Models

- AB*A12LATF
- AB*A14LATF
- AB*A18LATF
- AB*A24LATF



Flexible installation

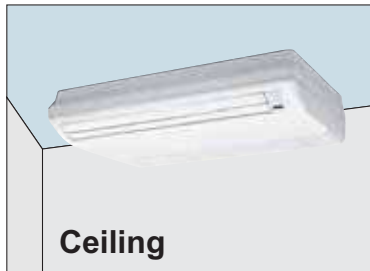

Specifications

Model name			AB*A12LATF	AB*A14LATF	AB*A18LATF	AB*A24LATF
Power source			220 to 240V 50Hz			
Capacity	Cooling	kW	3.60	4.05	5.30	6.60
	Heating		4.10	5.00	5.60	7.70
Input power		W	57	57	88	88
Airflow rate	High	m ³ /h	640	640	780	880
	Med		560	560	650	740
	Low		480	480	550	630
Sound pressure level	High	dB(A)	40	40	46	48
	Med		37	37	41.5	45
	Low		34	34	37	41
Dimensions (H x W x D)		mm	199 x 990 x 655	199 x 990 x 655	199 x 990 x 655	199 x 990 x 655
Weight		kg	28	28	28	28
Connection pipe diameter	Liquid (Flare)	mm	ø6.35	ø6.35	ø9.52	ø9.52
	Gas (Flare)		ø12.7	ø12.7	ø15.88	ø15.88

※AB*: ABY(FUJITSU), ABG(GENERAL)

Note : Specifications are based on the following conditions.

Cooling : Indoor temperature of 27°CDB / 19°CWB, and outdoor temperature of 35°CDB / 24°CWB.

Heating : Indoor temperature of 20°CDB / (15°CWB), and outdoor temperature of 7°CDB / 6°CWB.

Pipe length : 7.5 m; Height difference between outdoor unit and indoor unit : 0 m.

Voltage : 230 [V].

■ Double auto swing

A combination of up/down and right/left directional swing allows three-dimensional air direction control.

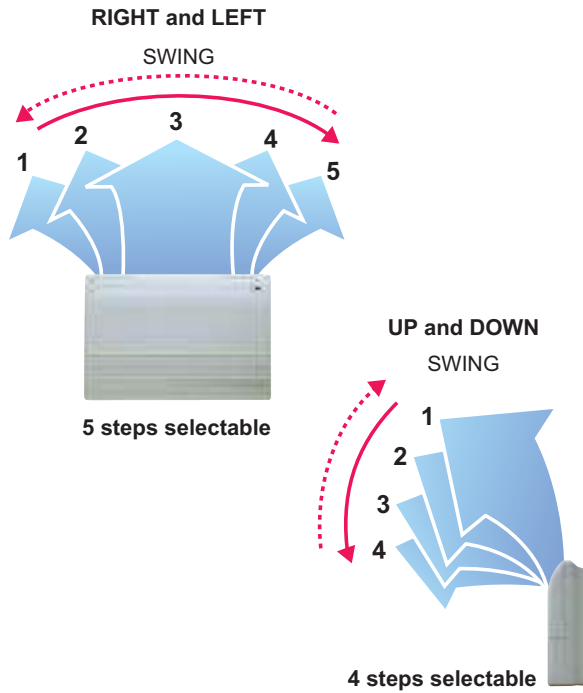

■ Super vane

Double-flap "Super Vane" with newly developed special configuration boosts air flow sending cool air quickly to every corner of the room.

■ Auto-closing louvre

This function is common to all indoor unit types except the duct type.

■ Compact design

Symmetrical, slim and compact design.

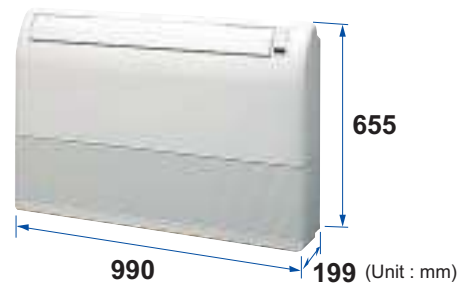

Dimensions

Models: AB*A12 / AB*A14 / AB*A18 / AB*A24

(Unit : mm)

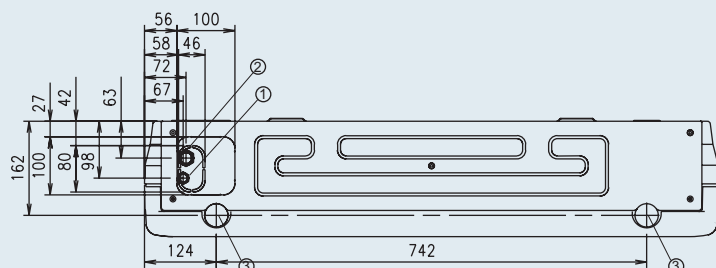
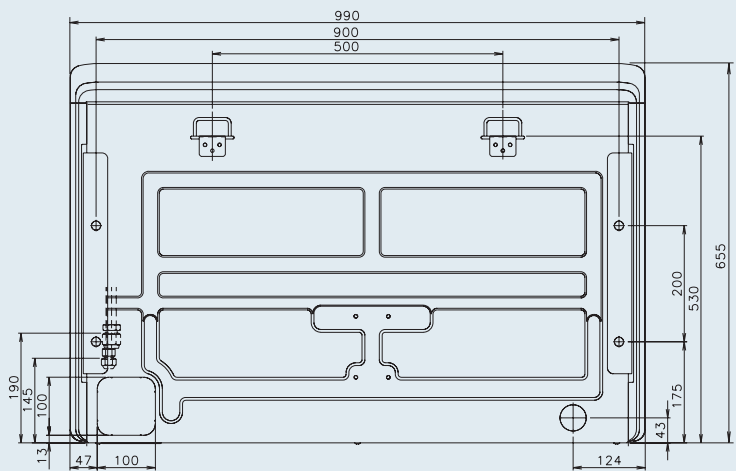
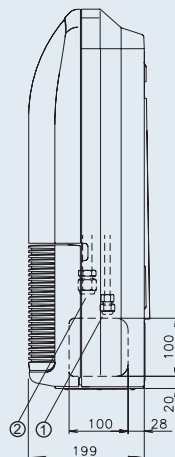

- ① Refrigerant piping flare connection (Liquid)
- ② Refrigerant piping flare connection (Gas)
- ③ Drain piping connection
(Drain pipe : I.D.Ø22 O.D.Ø25.6)
(Drain hose : I.D.Ø25 O.D.Ø29 L700)

Ceiling

Easily concealed in any installation

Models

AB*A30LATF
 AB*A36LATF
 AB*A45LATF
 AB*A54LATF



Installation

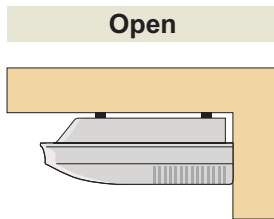

General installation pattern which suspends the indoor unit from the ceiling.

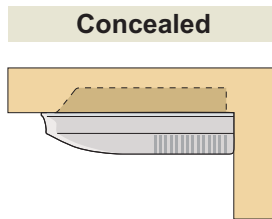

Installation pattern with part of the indoor unit embedded in the ceiling and fitted to the ceiling.

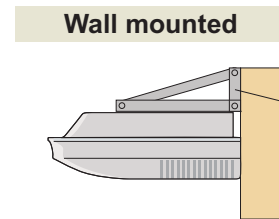

Pattern which fixes the indoor unit to a wall when it cannot be suspended because space behind the ceiling is narrow and the strength is insufficient.

Specifications

Model name			AB*A30LATF	AB*A36LATF	AB*A45LATF	AB*A54LATF
Power source			220 to 240V 50Hz			
Capacity	Cooling	kW	8.80	10.5	12.7	14.1
	Heating		9.10	12.7	13.7	15.8
Input power		W	124	144	160	180
Airflow rate	High	m ³ /h	1,450	1,660	1,850	2,200
	Med		1,280	1,500	1,660	2,000
	Low		980	1,270	1,430	1,800
Sound pressure level	High	dB(A)	42	45	48	52
	Med		39	42	46	50
	Low		35	37	41	46
Dimensions (H x W x D)		mm	240 x 1,660 x 700	240 x 1,660 x 700	240 x 1,660 x 700	240 x 1,660 x 700
Weight		kg	48	48	48	48
Connection pipe diameter	Liquid (Flare)	mm	ø9.52	ø9.52	ø9.52	ø9.52
	Gas (Flare)		ø15.88	ø19.05	ø19.05	ø19.05

※AB*: ABY(FUJITSU), ABG(GENERAL)

Note : Specifications are based on the following conditions.

Cooling : Indoor temperature of 27°CDB / 19°CWB, and outdoor temperature of 35°CDB / 24°CWB.

Heating : Indoor temperature of 20°CDB / (15°CWB), and outdoor temperature of 7°CDB / 6°CWB.

Pipe length : 7.5 m; Height difference between outdoor unit and indoor unit : 0 m.

Voltage : 230 [V].

■ Double auto swing and wide air flow

Auto air flow direction and auto swing

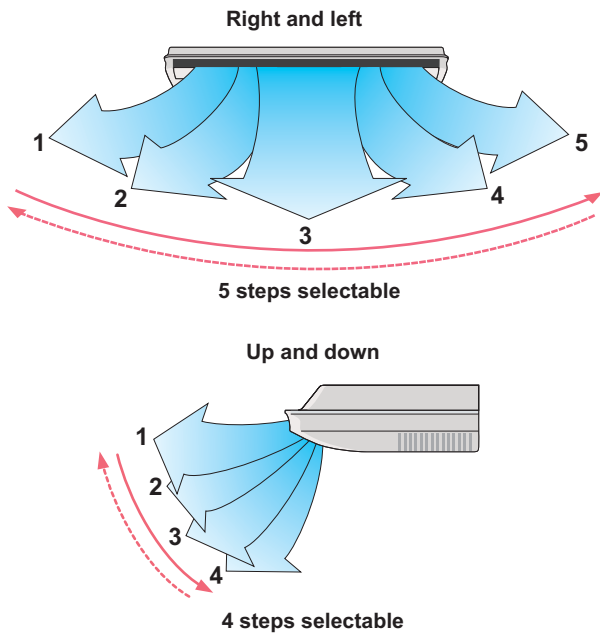

■ Long Air Flow

Long Airflow ensures comfort to every corner of a large room.

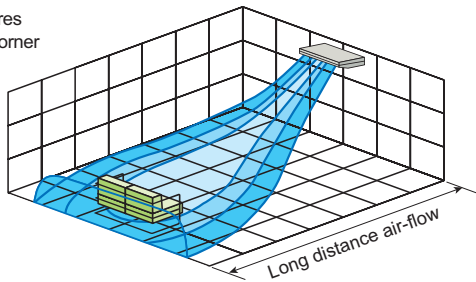

■ Slim & Compact design

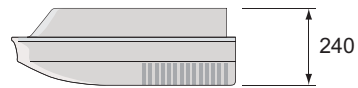

■ Condensate lift-up mechanism (Option)

Optional drain lift-up mechanism allows flexible installation.

Max.
500
mm

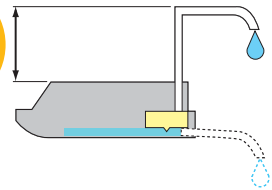

■ Fresh air intake

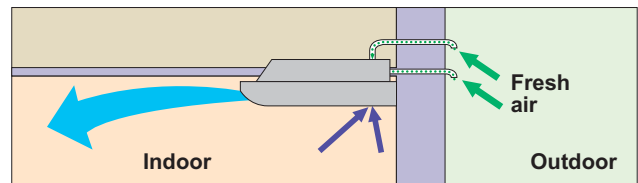

■ Long-life filter

High Efficiency long-life filter doubles the life of the filter compared to standard filters.

■ Optional parts

Drain water riser kit UTR-DPB24T

Dimensions

Models: AB*A30 / AB*A36 / AB*A45 / AB*A54

(Unit : mm)

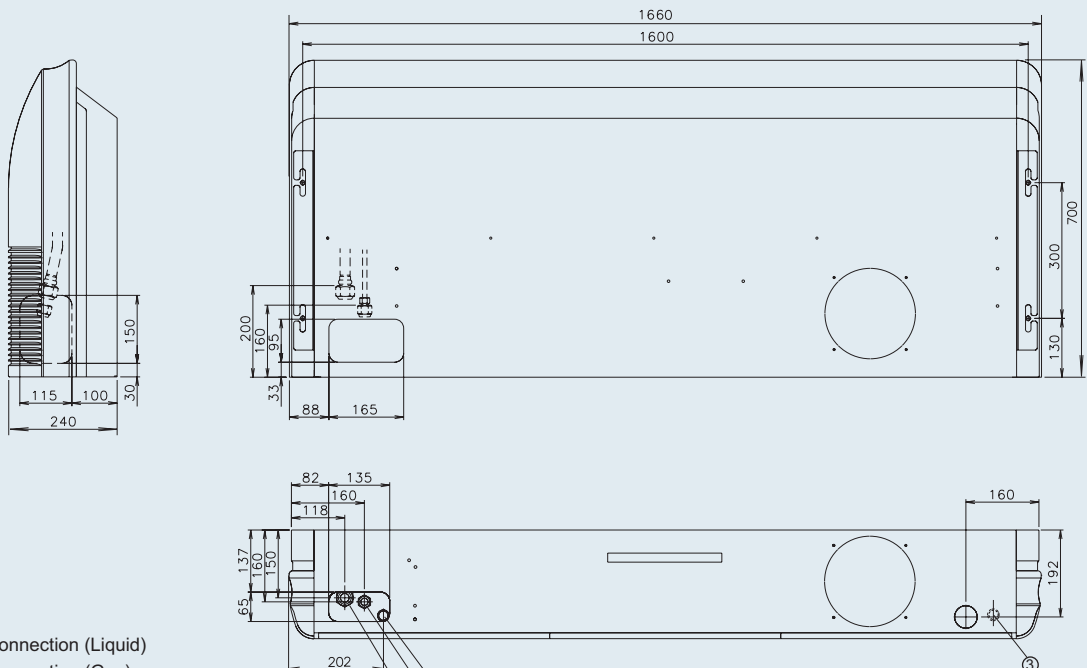

- ① Refrigerant piping flare connection (Liquid)
- ② Refrigerant piping flare connection (Gas)
- ③ Drain piping connection (Drain pipe : I.D.Ø22 O.D.Ø25.6)

Compact Wall Mounted Comfort model

This type of indoor unit is best suited to a room where a low noise level is required

Models

- AS*E07LACF
- AS*E09LACF
- AS*E12LACF
- AS*E14LACF



With this model, connection of EV kit is necessary.



Filter features



Apple-catechin filter

Fine dust, invisible mold spores, and harmful microorganisms are absorbed onto the filter by static electricity, and further growth is inhibited and deactivated by the polyphenol ingredient extracted from apples.



Long-life* Ion deodorization filter

The filter deodorizes by powerfully decomposing absorbed odors using the oxidizing and reducing effects of ions generated by the ultra-fine-particle ceramic.



Deodorizing effect (Odor reduction rate)

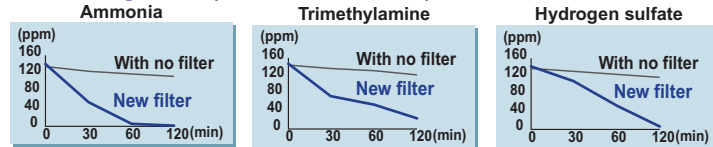

Testing organization : Environmental Sanitary Inspection Center Test method : Deodorization Test

* The filter can be used for approximately 3 years if it is washed under water to restore its surface action when it is dirty.

Specifications

Model name			AS*E07LACF	AS*E09LACF	AS*E12LACF	AS*E14LACF
Power source			220 to 240V 50Hz			
Capacity	Cooling	kW	2.20	2.80	3.60	4.00
	Heating	kW	2.50	3.20	4.10	4.80
Input power		W	13	13	17	19
Airflow rate	High	m ³ /h	490	490	560	600
	Med		450	450	480	490
	Low		370	370	420	420
Sound pressure level	High	dB(A)	34	34	38	39
	Med		32	32	34	35
	Low		26	26	30	30
Dimensions (H x W x D)		mm	275 x 790 x 215	275 x 790 x 215	275 x 790 x 215	275 x 790 x 215
Weight		kg	9	9	9	9
Connection pipe diameter	Liquid (Flare)	mm	ø6.35	ø6.35	ø6.35	ø6.35
	Gas (Flare)	mm	ø12.7	ø12.7	ø12.7	ø12.7
EV Kit			UTR-EV09XA (Option)		UTR-EV14XA (Option)	

※AS*: ASY(FUJITSU), ASG(GENERAL)

Note : Specifications are based on the following conditions.

Cooling : Indoor temperature of 27°CDB / 19°CWB, and outdoor temperature of 35°CDB / 24°CWB.

Heating : Indoor temperature of 20°CDB / (15°CWB), and outdoor temperature of 7°CDB / 6°CWB.

Pipe length : 7.5 m; Height difference between outdoor unit and indoor unit : 0 m.

Voltage : 230 [V].

Low noise

26dB (AS7)

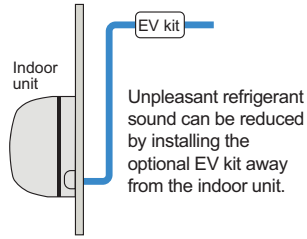

Compact size

Powerful output in spite of small size

Though the indoor unit is compact, it features a large, high pressure cross fan (90mm diameter) in a centre mounted configuration and a Lambda type heat exchanger to provide plenty of power.

Width 790 mm

Symmetrical design

Symmetrical, clean design that suits all interiors.



New Style High Power DC fan motor

- High power
- Wide rotation range
- High efficiency
- Compact size



Auto swing louvre

The Auto Swing Louvre function ensures that the air direction corresponds to the mode selected.

Cooling : 2-step (①-②)

Heating : 4-step (①-④)

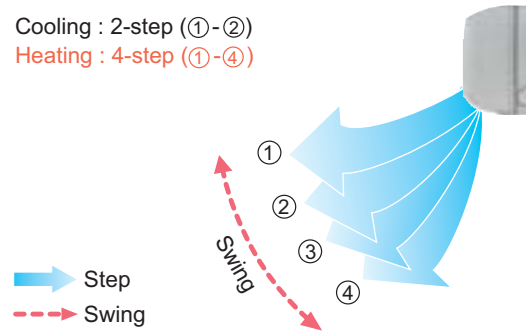

Easy maintenance

Easy maintenance has been realized as the front panel can be removed for easy access.



Wired-control acceptable



Wired and wireless remote controller are acceptable.



Dimensions

Models: AS*E07 / AS*E09 / AS*E12 / AS*E14

(Unit : mm)

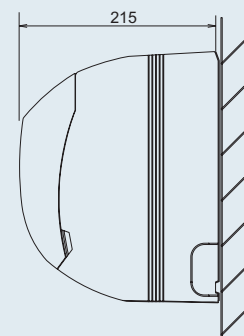
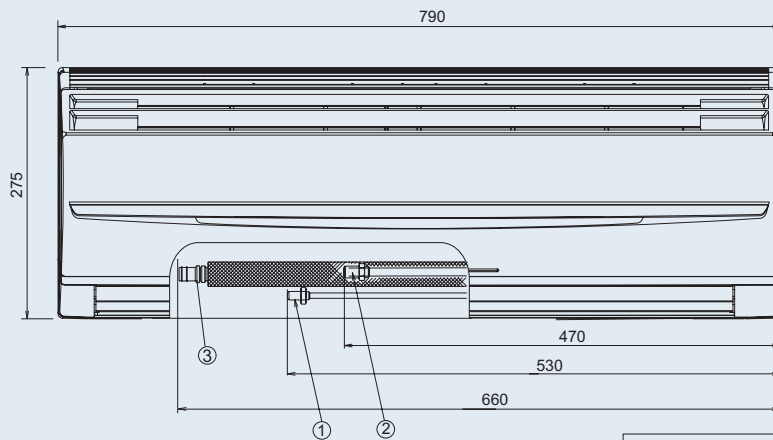

- ① Refrigerant pipe flare connection (Liquid)
- ② Refrigerant pipe flare connection (Gas)
- ③ Drain piping connection
(Drain hose : I.D.13.8 L600)

EV kit (UTR-EV09XA / UTR-EV14XA) Optional parts:

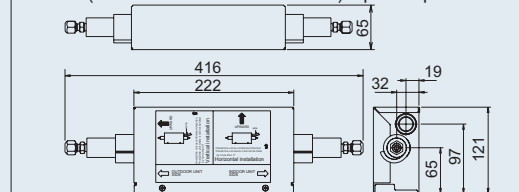

Wall Mounted

Double auto swing louver provides pleasant air flow to every corner of the room

Models

AS*A18LATF

AS*A24LATF

AS*A30LATF



Powerful output in spite of small size

Though the indoor unit is compact, it features a large, high pressure cross fan (107mm diameter) in a center mounted configuration and a lambda type heat exchanger to provide plenty of power. The extra long diffuser provides a wide outflow opening for air. This ensures a large air outflow volume over a wide area to cool or heat all areas of the room.



Specifications

Model name			AS*A18LATF	AS*A24LATF	AS*A30LATF
Power source			220 to 240V 50Hz		
Capacity	Cooling	kW	5.40	6.90	8.00
	Heating		5.60	7.80	8.80
Input power		W	38	50	60
Airflow rate	High	m ³ /h	800	970	1,040
	Med		650	870	910
	Low		550	750	730
Sound pressure level	High	dB(A)	41	45	47.5
	Med		36.5	41	44
	Low		33	37	39.5
Dimensions (H x W x D)		mm	320 x 1,120 x 220	320 x 1,120 x 220	320 x 1,120 x 220
Weight		kg	16	16	16
Connection pipe diameter	Liquid (Flare)	mm	ø9.52	ø9.52	ø9.52
	Gas (Flare)		ø15.88	ø15.88	ø15.88

※AS*: ASY(FUJITSU), ASG(GENERAL)

Note : Specifications are based on the following conditions.

Cooling : Indoor temperature of 27°CDB / 19°CWB, and outdoor temperature of 35°CDB / 24°CWB.

Heating : Indoor temperature of 20°CDB / (15°CWB), and outdoor temperature of 7°CDB / 6°CWB.

Pipe length : 7.5 m; Height difference between outdoor unit and indoor unit : 0 m.

Voltage : 230 [V].

Multi air flow

Large independently driven power diffuser used

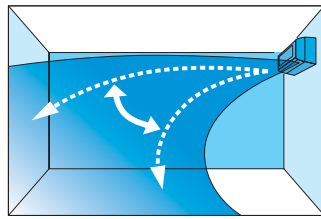

Horizontal concentration and other air direction control

➡ Steps
➡ Swing

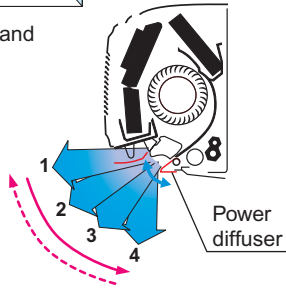

Cooling

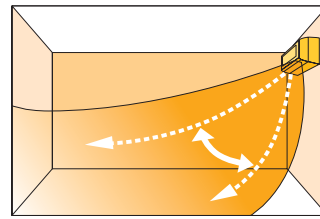

Wide down flow

➡ Steps
➡ Swing

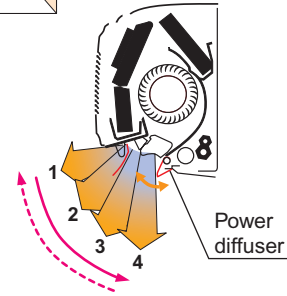

Heating

Large independently driven power diffuser

Low noise

· High efficiency fan construction ⇒
· ø7mm Lambda type evaporator improves the airflow path
· Large independently driven power diffuser

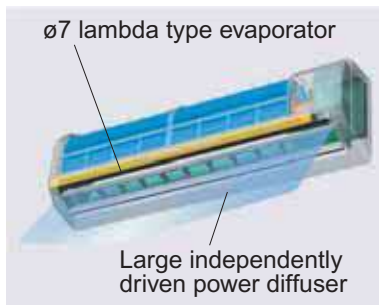

Low noise
33dB
(AS18)

Easier installation

Expanded work space at bottom of casing increases piping space by 15%.

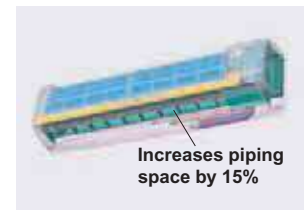

Others

- Double auto swing
- 2-way draining route

Dimensions

Models: AS*A18 / AS*A24 / AS*A30
(Unit : mm)

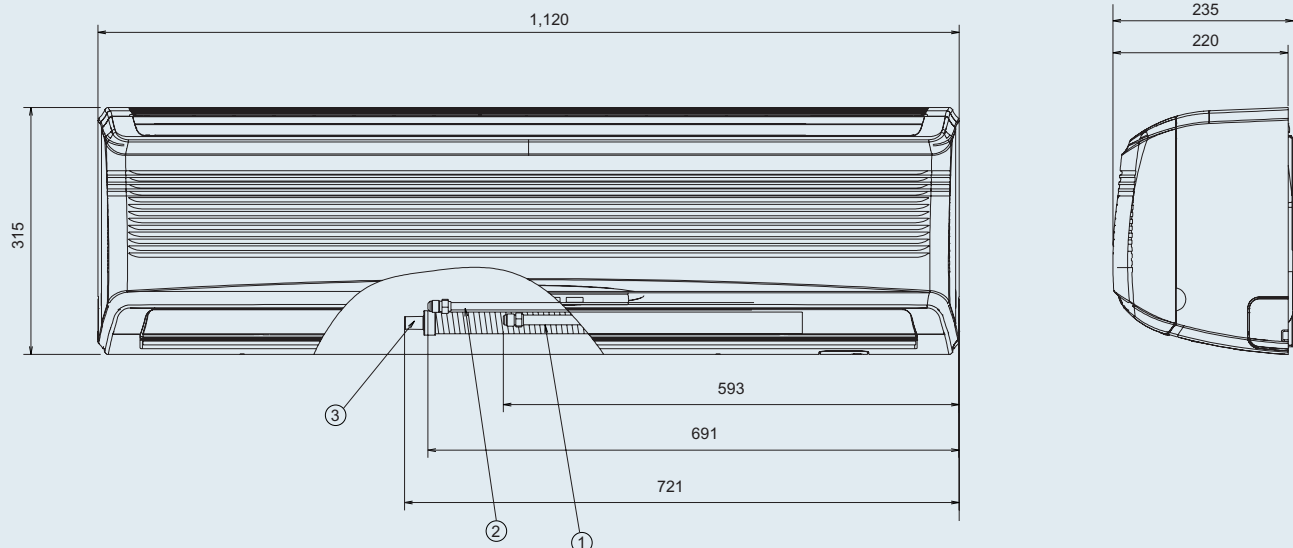

- ① Refrigerant piping flare connection (Gas)
- ② Refrigerant piping flare connection (Liquid)
- ③ Drain piping connection
(Drain hose : I.D.Ø17 O.D.Ø24 L670)

Ceiling Wall

Attractive unit to which can be installed 40mm from the ceiling

Models

AW*A07LATF
 AW*A09LATF
 AW*A12LATF
 AW*A14LATF
 AW*A18LATF
 AW*A24LATF
 AW*A30LATF



Larger, wider airflow

Introduction of the top air intake reduces the curvature of the air flow path thereby achieving lower air resistance, lower noise and larger air volume.

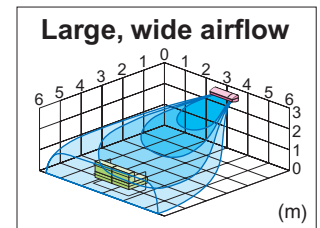
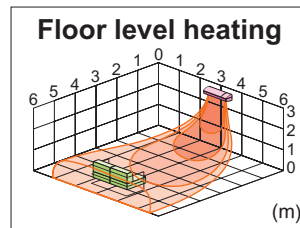
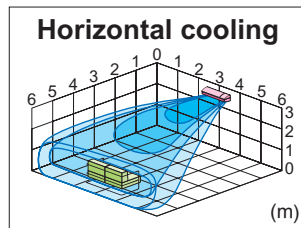

Specifications

Model name			AW*A07LATF	AW*A09LATF	AW*A12LATF	AW*A14LATF	AW*A18LATF	AW*A24LATF	AW*A30LATF
Power source			220 to 240V 50Hz						
Capacity	Cooling	kW	2.20	2.80	3.60	4.30	5.40	6.90	8.00
	Heating	kW	2.50	3.20	4.10	4.90	5.60	7.80	8.80
Input power		W	16	19	20	21	30	40	50
Airflow rate	High	m ³ /h	380	480	600	650	760	900	950
	Med		330	420	520	570	660	780	870
	Low		290	390	470	490	560	650	780
Sound pressure level	High	dB(A)	34	35	35	37	40	44	47
	Med		32	32	33	35	37	41	45
	Low		30	30	31	32	34	37	42
Dimensions (H x W x D)		mm	270 x 1,150 x 285	270 x 1,150 x 285	270 x 1,150 x 285	270 x 1,150 x 285	270 x 1,150 x 285	270 x 1,150 x 285	270 x 1,150 x 285
Weight		kg	16	16	16	16	16	16	16
Connection pipe diameter	Liquid (Flare)	mm	ø6.35	ø6.35	ø6.35	ø6.35	ø9.52	ø9.52	ø9.52
	Gas (Flare)	mm	ø12.7	ø9.52	ø12.7	ø12.7	ø15.88	ø15.88	ø15.88

※AW*: AWY(FUJITSU), AWG(GENERAL)

Note : Specifications are based on the following conditions.

Cooling : Indoor temperature of 27°CDB / 19°CWB, and outdoor temperature of 35°CDB / 24°CWB.

Heating : Indoor temperature of 20°CDB / (15°CWB), and outdoor temperature of 7°CDB / 6°CWB.

Pipe length : 7.5 m; Height difference between outdoor unit and indoor unit : 0 m.

Voltage : 230 [V].

Interior emphasized simple form

Optimum design for rooms in which you want to enjoy the interior design. This is our unique design which allows installation at a high position (on the wall near the ceiling).

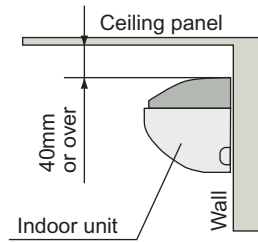
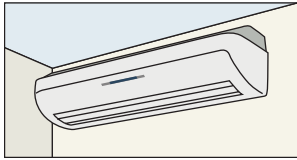

Easy maintenance

Drain pan can be easily removed for thorough washing without removing the unit from the wall.

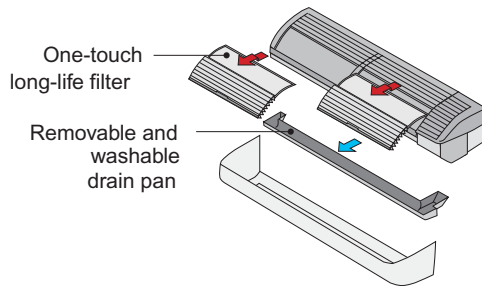

Long-life filter

- Long-life filter can be removed with one touch.
- Long-life filter extends the cleaning cycle by a factor of three.

High efficiency

High output and high efficiency are achieved by using a DC motor.

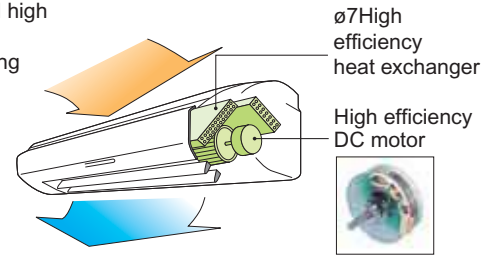

Low noise

Suppressing the turbulence by providing vertical grooves on the quiet louver and the right/left louver reduces annoying noise.



Large airflow and low noise achieved by top air intake.

Outlet louver reduces annoying noise

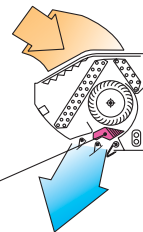

Others

- Double auto swing (Right and left, up and down)
- 2-way draining route

Dimensions

Models: AW*A07 / AW*A09 / AW*A12 / AW*A14
AW*A18 / AW*A24 / AW*A30

(Unit : mm)

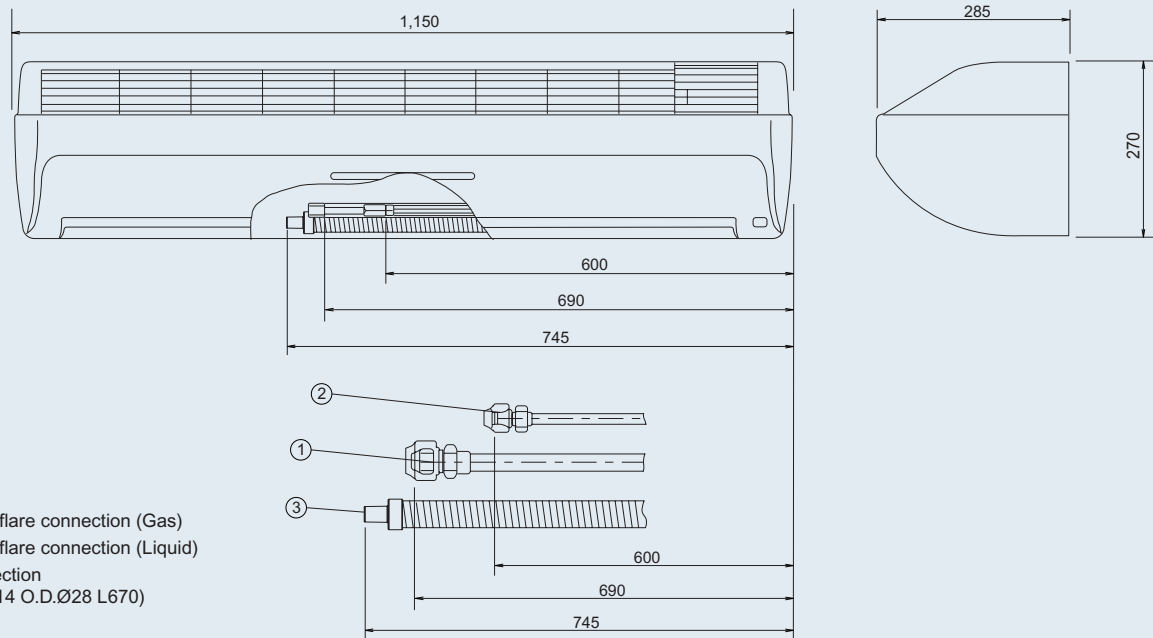

- ① Refrigerant piping flare connection (Gas)
- ② Refrigerant piping flare connection (Liquid)
- ③ Drain piping connection
(Drain pipe : I.D.Ø14 O.D.Ø28 L670)

Optional Parts

Connection Tube

Separation Tube

Model : UTR-BP090X / UTR-BP090L

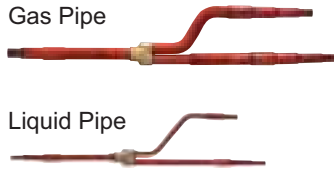

Separation Tube

Model : UTR-BP180X / UTR-BP180L

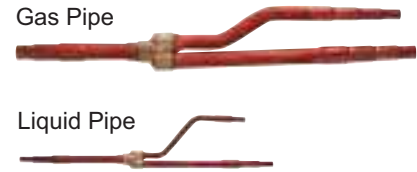

Separation Tube

Model : UTR-BP567X / UTR-BP567L

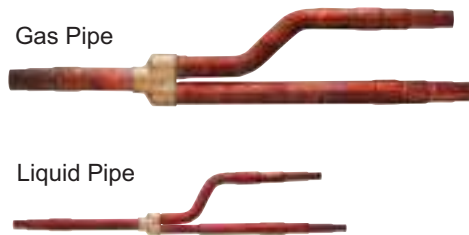

Outdoor Unit Branch kit

Model : UTR-CP567X / UTR-CP567L

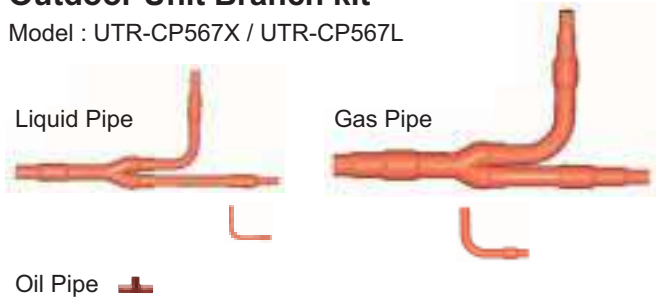

Header

Model : UTR-H0906L
UTR-H1806L

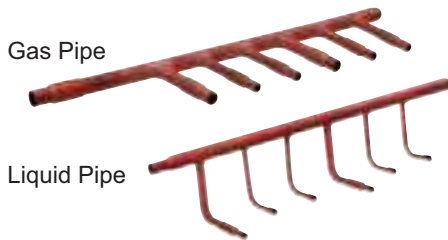

Header

Model : UTR-H0908L
UTR-H1808L

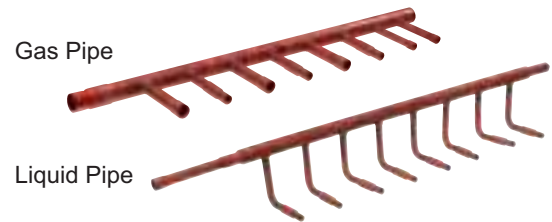

Outdoor unit Branch kit

Outdoor unit	Model	Q'ty
2 outdoor units	UTR-CP567X / UTR-CP567L	1
3 outdoor units		2

Indoor side Branch kit

Separation Tube

Total model code of indoor unit	Separation Tube
90 or less	UTR-BP090X / UTR-BP090L
91 to 180	UTR-BP180X / UTR-BP180L
181 or more	UTR-BP567X / UTR-BP567L

Header

Total model code of indoor unit	Header	
	6 Branches	8 Branches
90 or less	UTR-H0906L	UTR-H0908L
91 to 180	UTR-H1806L	UTR-H1808L

EV kit

These models are used for Compact Wall Mounted Type(Comfort model) AS*E07LATF, AS*E09LATF, AS*E12LATF, AS*E14LATF

Application Model	Model
AS*E07LATF AS*E09LATF	UTR-EV09XA
AS*E12LATF AS*E14LATF	UTR-EV14XA

Others

Flange (Square)

Model : UTD-SF045T



For Low Static Pressure Duct type / Duct type

Flange (Round)

Model : UTD-RF204



For Low Static Pressure Duct type / Duct type

Long-life filter

Model : UTD-LF25NA

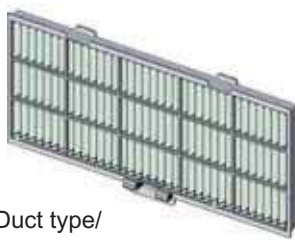

For Low Static Pressure Duct type/
Duct type

Long-life filter

Model : UTD-LF60KA



For High Static Pressure Duct type

Drain Water Riser Kit

Model : UTR-DPB24T

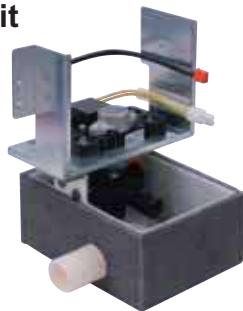

For Ceiling type

Remote Sensor Unit

Model : UTD-RS100



Grille Kit

Model : UTG-UDYD-W
UTG-UDGD-W



For Compact Cassette type

EV Kit

Model code < 09 :
UTR-EV09XA
Model code \geq 12 :
UTR-EV14XA



For Compact Wall Mounted (Comfort model) type



ISO 9001
Certified number:09 100 79269
Fujitsu General (Shanghai) Co., Ltd.



ISO 14001
Certified number:104692
Fujitsu General (Shanghai) Co., Ltd.



ISO 9001
Certified number:09 100 89394
Fujitsu General (Thailand) Co., Ltd.

ISO 14001
Certified number:09 104 9245
Fujitsu General (Thailand) Co., Ltd.

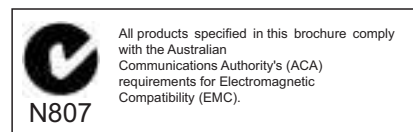

All products specified in this brochure comply with the Australian Communications Authority's (ACA) requirements for Electromagnetic Compatibility (EMC).

"**AIRSTAGE™**" is a worldwide trademark of FUJITSU GENERAL LIMITED.

- *Microsoft® and Windows® are registered trademarks of Microsoft Corporation in the United States.
- *Adobe® and Acrobat Reader® are registered trademarks of Adobe Systems Incorporated in the United States.
- *Intel®, Pentium® and Celeron® are registered trademark of Intel Corporation or its subsidiaries in the United States.
- *AMD Athlon™ and AMD Duron™ are registered trademark of Advanced Micro Devices, Inc.
- *Echelon®, LONWORKS®, and the Echelon logo are trademarks of Echelon Corporation registered in the United States and other countries.
- *BACnet® is a registered trademark of the American Society of Heating Refrigeration and Air Conditioning Engineers (ASHRAE).

Product specifications are subject to change without notice.

Copyright© 2006-2007 Fujitsu General Limited. All rights reserved.

Distributed by :

FUJITSU GENERAL LIMITED
1116, Suenaga, Takatsu-ku, Kawasaki 213-8502, Japan
URL : <http://www.fujitsu-general.com>

2007.06.25 VB015E/05 Printed in Japan